

freund 

I Am Your Hand





Milwaukee
M18 FUEL

5.0 Ah
M18
RED LITHIUM-ION

freund Seaming Pro by beyotec

P.F. Freund & Co. GmbH
Technologie Center 10 | D-12105 Regensburg, Germany
Tel: +49 (0) 9401 90000
Fax: +49 (0) 9401 90001
E-Mail: info@pf-freund.com
www.pf-freund.com

A

B

Overview Topics & Product Groups

New

Only one click away.
Integrated click function
of the product groups to
the respective page.



Freund

A roof over everyone's head 6

Product Overview

Slate & fibre cement	9
Demolition tools	31
Roofer's hammer	38
Woodworking	41
Tileworking	43
Flat roof	48
Hammer tacker & staples	72
Knives & blades	78
Saws	89
Trowels	96
Foam & chaulking guns	100
Measuring & marking	106
Seaming machine	
Seaming Pro® New Generation	122
Bender	130
Seaming pliers	138
Sheet metal pliers	156
Bending & seaming tools	164
Snips	176
Sheet metal forming	192
Tinman's hammer	206
Gutters & pipes	214
Soldering & riveting tools	227
Hand riveters & rivets	239
Leather products	242
Tool boxes	247
What you need else	250

General

Index 258

Ready
For
Our
New
Products?

Click me

Your new top sellers,
just one click away.
Simple click function,
each headline - a topseller.



Cutting
Simple - Does It Tw
The World's Lightes

Brilliant On Sheet
Full View On The
Have The So You
One For All

Let's
Go!

A Roof Over Everyone's Head.

That is our why. And our goal! We work on it every day. With top performance in the team. With you. For you. And together for your customers. To satisfy a basic need. And to secure it!

With this goal you trust and insist on our system of premium products. And on our quality. A quality that has made no compromises for more than 175 years. A quality with the highest comfort and unique advantages. A quality that accompanies you every day. Wherever your passion lies. On the roof or on the facade.

Because Freund produces and sells hand tools for roofers, sheet metal specialists, carpenters and flat roof installers. Nationally and internationally. Leading in the market. With products that are unmistakable and indispensable for you.

With products that we are constantly developing. Or include completely new products in our range. To get the best for you. And we can only do that with a clear strategy. With a clear definition of goals, standards and structures. We always go one step further. We are creative and innovative. Consistent and courageous. For new paths. For the highest quality. For the existence of our brand. For ensuring our common goal.

Unmistakable and indispensable

Our Icons

General



Design Award



Color Variants



Friend Choice



Handmade



New



PVC-Jaws



Pipe-opening

Diameter 6D Pipe Expander



60 mm



76 mm



80 mm



87 mm



100 mm



120 mm

Staples



11/10 mm Flatwire



11/14 mm Flatwire



37/6 mm Roundwire



37/8 mm Roundwire

Ball bearings



Bush Bearings



Smooth Running Ball Bearings

Cut radii



Straight



Notching



Smalles Radii



Small Radii Right



Small Radii Left

Patent



Patent



M. Radien rechts



Medium Radii Left



Straigh/L. Radii Right



Straigh/L. Radii Left

Pliers trade



Stack Joint



Lap Joint



Slater's Hammer Universo®

Application

Perfect performer: It punches, trims and processes slate. And it pulls nails!



Benefits & Comfort

- Universal: Double bevel grinding on the working side - no need to change tools, in addition you can work on both sides of the slater's anvil
- Flexible: One-sided circular grinding of the head for creating large radii
- Non-slip and breathable: Handcrafted leather handle absorbs the strike
- Sound-optimized and durable: Thanks to Freund hardening process by hand
- Stable and safe: You guide the hammer precisely through the leather handle
- Balanced: Tool weight is ideally allocated

Item no. 00020651

Item no.	Version	Dimensions	Weight	PU
00020651	Slater's hammer Universo®, right	340 x 220 mm	650 g	1
00021651	Slater's hammer Universo®, left	340 x 220 mm	650 g	1



Because craftsmanship is everything

With the Universo® you do not only work safely and effortlessly - but also quickly and precisely. Because it is handmade for your hand. So it saves energy, is easy on your joints and your hearing - for a long time.

Slater's Hammer Rhenish Pattern

Application & Benefits

Precise all-round genius:
It punches, trims, processes and fixes slate!

- Non-slip and breathable: Handcrafted leather handle absorbs the strike
- Balanced: Tool weight is ideally allocated
- Sound optimized and durable: With a lot of experience our slate hammers are hardened by hand



Item no. 00020600

Slater's Hammer Saxon Pattern

Application & Benefits

Helping Saxon: It punches, trims and processes slate!

- Non-slip and breathable: Handcrafted leather handle absorbs the strike
- Sound optimized and durable: With a lot of experience our slate hammers are hardened by hand
- Robust and long lasting: Increased durability of the tip and cutting edge



Item no. 00040000

Slater's Hammer American Pattern

Application & Benefits

Precise Allrounder: It punches, shapes, and trims slate. And it pulls nails!

- Special: Double sided nail puller
- Non-slip and breathable: Handcrafted leather handle absorbs the strike
- Sound optimized and durable: With a lot of experience our slate hammers are hardened by hand



Item no. 00052000

item no.	Version	Dimensions	Weight	PU
00020600	Slater's hammer rhenish pattern light, right	340 mm	600 g	1
00020650	Slater's hammer rhenish pattern, right	340 mm	650 g	1
00021650	Slater's hammer rhenish pattern, left	340 mm	650 g	1
00040000	Slater's hammer saxon pattern, right	335 mm	650 g	1
00052000	Slater's hammer american pattern, right	320 mm	680 g	1
00053000	Slater's hammer american pattern, left	320 mm	680 g	1

Slater's Hammer French Pattern

Application & Benefits

Precise Frenchman: It punches, shapes and trims slate. And it pulls nails!

- Special: Double sided nail puller
- Non-slip and breathable: Handcrafted leather handle absorbs the strike
- Sound optimized and durable: With a lot of experience our slate hammers are hardened by hand



Item no. 00050000

Slater's Hammer Traditional French Pattern

Application & Benefits

Precise Frenchman: It punches, shapes and trims slate. And it pulls nails!

- Special: Double sided nail puller
- Non-slip and breathable: Handcrafted leather handle absorbs the strike
- Powerful: High head weight increases the striking power



Item no. 00054000

Slater's Hammer Universo® French Pattern

Application & Benefits

Precise Frenchman: It punches, shapes and trims slate. And it pulls nails!

- Special: Double sided nail puller
- Universal: Double bevel grinding on the working side - no need to change tools in addition, you can work on both sides of the Slater's anvil
- Flexible: One-sided circular grinding of the head for creating further radii



Item no. 00058000

Item no.	Version	Dimensions	Weight	PU
00050000	Slater's hammer french pattern, right	330 mm	660 g	1
00051000	Slater's hammer french pattern, left	330 mm	660 g	1
00054000	Slater's hammer traditional french pattern, right	330 mm	680 g	1
00058000	Slater's hammer Universo® french pattern, right	340 mm	650 g	1

Slater's Hammer Universo® Ornament

Application

Fine decorator: Especially for creating and processing of slate ornaments!



Benefits & Comfort

- Fine: With hand-ground and rounded modeling surface to create curves and shapes
- Universal: Double bevel grinding on the working side - no need to change tools in addition, you can work on both sides of the slater's anvil
- Particularly light and fine: Hand made leather handle - absorbs the impact
- Sound optimized and durable: With a lot of experience our slate hammers are hardened by hand
- Balanced: Tool weight is ideally distributed
- Stable and safe: The leather handle allows you to guide the the hammer precisely



Item no. 00074000

Item no.	Version	Dimensions	Weight	PU
00074000	Slater's hammer Universo® ornament, right	280 x 180 mm	420 g	1
00074001	Slater's hammer Universo® ornament, left	280 x 180 mm	420 g	1



Because detail work matters

Fast and fine - the particularly light and durable Universo® Ornament makes it possible. Because we have made it by hand. So that you can safely and effortlessly work down to the last detail. Without great effort. And gentle on your joints.

Slater's Hammer Universo® Modeling

Application & Benefits

Artists decorator: Specially designed for creating slate ornaments!

- Fine: With hand-ground and rounded modeling surface to create curves and shapes
- Universal: Double bevel grinding on the working side - no need to change tools
- Handcrafted leather handle absorbs the strike



Item no. 00075000

Slater's Hammer Piccolo with Three Holes

Application & Benefits

Small allrounder: It punches, shapes and trims slate!

- Lightweight: Compact construction of the tool
- Non-slip and breathable: Handcrafted leather handle absorbs the strike
- Sound optimized and durable: With a lot of experience our slate hammers are hardened by hand



Item no. 00070000

Slater's Hammer Piccolo with Nail Puller

Application & Benefits

Small allrounder: It punches, shapes and trims slate! And it pulls nails!

- Lightweight: Compact construction of the tool
- Non-slip and breathable: Handcrafted leather handle absorbs the strike
- Sound optimized and durable: With a lot of experience our slate hammers are hardened by hand



Item no. 00072000

Item no.	Version	Dimensions	Weight	PU
00075000	Slater's hammer Universo® modeling, right	300 mm	350 g	1
00075001	Slater's hammer Universo® modeling, left	300 mm	350 g	1
00070000	Slater's hammer Piccolo three holes, right	300 mm	475 g	1
00072000	Slater's hammer Piccolo with nail puller, right	300 mm	475 g	1

Pointing Hammer with Wooden Handle

Application & Benefits

Precise Allrounder:
He punches, shapes, and trims slate. And it pulls nails!

- Pleasant: Premium natural wood handle
- Safe: Highest working safety through reinforced and extremely stable head safety device
- Durable: Thanks to Freund hardening process by hand



Item no. 00130000

Pointing Hammer with Fiberglass Handle

Application & Benefits

Precise Allrounder:
He punches, shapes, and trims slate. And it pulls nails!

- Durable: handle made of high-quality glass fiber
- Safe: Firm anchoring of head and handle
- Universal: Flexible application thanks to hole and nail function



Item no. 00132000

Item no.	Version	Dimensions	Weight	PU
00130000	Pointing hammer with wooden handle	330 mm	375 g	1
00132000	Pointing hammer with fiberglass handle	330 mm	375 g	1



**Hold It
The Right
Way Round**

Slate- & Fibre Cement Cutter MasterCut®

Application

Robust Expert: Cuts and punches slate and fiber cement tiles up to 7 millimeters thick!



Benefits & Comfort

- Flexible: Cuts fiber cement slate with one side and natural slate with the other. Simply turn over
- Convenient: Integrated hole punch with a stable and unbreakable spring
- High quality: Die-cast aluminum body, easy to maintain
- Robust: Despite its multiple usability, MasterCut® consists of only a few components
- Safe: Protects the hand from pinching when cutting
- Ergonomic: Pleasant soft grips for smooth work



Item no. 00950000

Item no.	Version	Dimensions	Weight	PU
00950000	Slate- & fibre cement cutter MasterCut®	335 x 80 mm	780 g	1



Hold it the right way round

Our award-winning masterpiece: You cut fiber cement tiles with the centimeter scale pointing upwards. And for slate, simply turn the MasterCut® upside down! For easier cutting than ever before and maximum work safety.

Slate- & Fibre Cement Cutter ErgoCut with Punch

Application & Benefits

Handy expert: Cuts and punches natural slate and fiber cement!

- Convenient: The compact and handy design offers you a perfect handling
- Universal: Cutting and punching with only one device
- Lasting: The blade lasts for a long time and does not need to be changed



Item no. 00920000

Slate- & Fibre Cement Cutter with Punch

Application & Benefits

Comfortable expert: Cuts and punches natural slate and fiber cement!

- Comfortable: Dust and breakout free cutting process
- Fast: Cutting length of 35 mm and cutting width of 2.8 mm
- Universal: Cutting and punching with only one device



Item no. 00920009

Slate- & Fibre Cement Cutter without Punch

Application & Benefits

Simple worker: Cuts and punches natural slate and fiber cement!

- Comfortable: Dust and breakout free cutting process
- Fast: Cutting length of 35 mm and cutting width of 2.8 mm
- Practical: Blades replaceable



Item no. 00930009

Item no.	Version	Dimensions	Weight	PU
00920000	Slate- & fibre cement cutter Ergocut with punch	300 mm	630 g	1
00920009	Slate- & fibre cement cutter with punch	310 mm	825 g	1
00930009	Slate- & fibre cement cutter without punch	300 mm	645 g	1

Slater's Anvil HAU.MAXX, Curved

Application

A gifted bow artist: For a quick and exact trimming of slates!

Benefits & Comfort

- Ergonomic and safe: Thanks to the recessed grips, the anvil lies securely in your hand when hammering it in
- Durable: Made from one piece and powder-coated
- Sound optimized: Specific recess in the material
- Light and fast: Hammering into the wood is very comfortable thanks to the curved hammering tip



Item no. 00316000

Item no.	Version	Dimensions	Weight	PU
00316000	Slater's anvil HAU.MAXX, curved	300 x 185 mm	440 g	1



Because you have the hang of it

The curved HAU.MAXX makes the trimming of slate a piece of cake. The recessed grips fit perfectly in your hand. Thanks to its shining color, you can always find it quickly. And it's easy on your ears while you work. The perfect addition to the straight HAU.MAXX.

Slater's Anvil HAU.MAXX, Straight

Application

Consequent divider: For fast and exact processing of fiber cement and slate tiles!

Benefits & Comfort

- Ergonomic and safe: Thanks to the recessed grips the bridge lies securely in your hand when hammering it in
- Durable: Made from one piece and powder coated
- Sound optimized: Targeted recess in the material
- Light and fast: Hammering into the wood is very comfortable thanks to the curved hammering tip
- Flexible: Also suitable for slates



Item no. 00315000

Item no.	Version	Dimensions	Weight	PU
00315000	Slater's anvil HAU.MAXX, straight	310 x 200 mm	450 g	1

Because we always switch to green for you

Grab it and go - that's HAU.MAXX. It makes working with fiber cement tiles and slate tiles super easy. The recessed grips fit perfectly in your hand. Thanks to its shining color, you can always find it quickly. And it's easy on your ears while you work. The perfect addition to the curved HAU.MAXX.

Slater's Anvil Curved

Application & Benefits

Forming divider: Processes slate tiles!

- Light or heavy: Slater's anvil in 2 thicknesses, each made from one piece: 5 mm and 8 mm
- Safe: Ground edges
- Practical: Hammering into the wood is very comfortable thanks to the curved hammering tip
- Durable: Made from one piece



Item no. 00311000

Slater's Anvil Straight

Application & Benefits

Forming divider: Processes fibre cement and slate tiles!

- Your choice: Light 5 mm, heavy 8 mm or extra long slater's anvil
- Safe: Ground edges
- Practical: Hammering into the wood is very comfortable thanks to the curved hammering tip
- Durable: Made from one piece



Item no. 00310000

Item no.	Version	Dimensions	Weight	PU
00311000	Slater's anvil curved, light version, 5 mm thick	310 x 185 mm	560 g	1
00313000	Slater's anvil curved, heavy version, 8 mm thick	310 x 185 mm	800 g	1
00310000	Slater's anvil straight, light version, 5 mm thick	310 x 185 mm	560 g	1
00312000	Slater's anvil straight, heavy version, 8 mm thick	310 x 185 mm	800 g	1
00314400	Slater's anvil straight, long version, 5 mm thick	400 x 200 mm	725 g	1

Slater's Anvil French Pattern Long

Application & Benefits

**French divider: Processes
Slate and fiber cement tiles!**

- Long: 400 mm support
- Cutting: Ground on one side bevel for right- or left-handed use
- Durable: Made from one piece



Item no. 00324400

Slater's Anvil French Pattern Short

Application & Benefits

**French divider: Processes
Slate and fiber cement tiles!**

- Short: 310 mm support
- Cutting: Ground on one side bevel for right- or left-handed use
- Durable: Made from one piece



Item no. 00320000

Item no.	Version	Dimensions	Weight	PU
00324400	Slater's anvil french pattern, long, straight, right	400 x 200 mm	725 g	1
00325400	Slater's anvil french pattern, long, straight, left	400 x 200 mm	725 g	1
00320000	Slater's anvil french pattern, short, straight, right	310 x 185 mm	560 g	1
00321000	Slater's anvil french pattern, short, straight, left	310 x 185 mm	560 g	1

Slate Cutter Schiefermax

Application

Flexible allrounder: Processes slate tiles up to 10 millimeters thick!

Benefits & Comfort

- **Strong:** The ergonomic cutting edge can process tiles up to 10 mm
- **Large format:** The blade runs through the tile without interfering stop for formats up to 50 cm
- **Safe:** The slate cutter is hooked into the battening and can be easily transported thanks to the safety pin
- **Durable:** The hardened knife is made of high-quality tool steel
- **Ergonomic:** The handle is wavy and fits well in your hand
- **Comfortable:** Low maintenance due to easily accessible components



Item no. 00351000



Item no. 00352000



Item no. 00350000

Item no.	Version	Dimensions	Weight	PU
00350000	Slate cutter Schiefermax	600 x 200 mm	5.2 kg	1
Accessories:				
00351000	Guide	430 mm	1 kg	1
00352000	Punching device	440 mm	900 g	1
	replacement punch consists of steel nail 3.4 x 40 mm			



Only the hard ones survive

Schiefermax cuts even extremely hard slate. A piece of cake - even if you have to make the same cuts over and over again. The optional guide makes it possible and gives you the comfort you need. Speaking of convenience: The cutting length is extra long. And the maintenance effort is extra low.

Fibre Cement Guillotine 96

Application

Exact expert: Cuts and punches facade panels from fiber cement up to 6 millimeters thick!

Benefits & Comfort

- Energy-saving: The lightweight aluminum body and the precisely balanced carrying handle simplify transport
- Razor-sharp: Clean cut and punched holes
- Convenient: Perfect geometry and precise cutting ensure fast and easy work, even with large panels (cutting length 800 mm)
- Flexible: Built-in additional blade for short cuts saves tool changes
- Comprehensive: With two built-in hole punching devices the material can be processed completely
- Practical: Low maintenance due to easily accessible components
- Unsuitable: Not for natural slate



Item no. 00960000

Item no.	Version	Knife length	Dimensions	Weight	PU
00960000	Fibre cement guillotine 96	800 mm	9600 x 4.200 mm	15.2 kg	1
Spare part:					
17723	1 Spare blade (2 spare blades necessary)	800 mm		300 g	1



Because solid can also be light

The fibre cement guillotine always shows greatness. No wonder, each one is made with attention to detail and tested by hand. The best tool steel for blades and punches ensures top performance. For example thanks to the Solingen steel blade, adjusted by hand.

Guide For Fibre Cement Guillotine

Application & Benefits

Precise shaper: It gives fiber cement consistent cuts!

- Time-saving: One-time adjustment of the the guide rail for many identical boards without marking
- Double: Adjustable in angle from 0-90° as well as 45 to 310 mm
- Light: Use of aluminum



Item no. 00960001

Fibre-Cement Scribe with Carbide Exchange Blade

Application & Benefits

Precise scribe: It tears a wide variety of materials!

- A wide variety of materials!
- Durable: cutting edge is made of carbide
- Light and robust: Die-cast aluminum housing
- Powerful: Optimum power transfer through integrated thumb rest



Item no. 05610000

Item no.	Version	Knife length	Dimensions	Weight	PU
00960001	Guide for fibre cement guillotine for 00960000 and 00970000		450 mm	2 kg	1
05610000	Fibre cement scribe with carbide exchange blade		150 mm	135 g	1
Spare part:					
05611000	Carbide exchange blade		70 mm	20 g	1

Slate Ripper Handforged

Application

Indispensable one of a kind: Removes slate nails from overlaps!



Freund
Choice



Handmade

Benefits & Comfort

- Traditional: Free hand forged for 175 years and inspected
- Durable: Made from one piece of forged steel
- Robust: Seamless manufacturing with no welds, which can crack
- Flexible: Asymmetrical positioning of the nail pullers right and left for flexible working depth
- Practical: Integrated nail claw on the handle



Item no. 00240400

Item no.	Version	Dimensions	Weight	PU
00240315	Slate ripper, 2 nail puller	315 mm	575 g	1
00240400	Slate ripper, 4 nail puller	400 mm	625 g	1
00240470	 Slate ripper, 4 nail puller	470 mm	725 g	1
00240525	Slate ripper, 4 nail puller	525 mm	750 g	1
00240600	Slate ripper, 4 nail puller	600 mm	830 g	1
00240650	Slate ripper, 4 nail puller	650 mm	875 g	1



Because tradition never gets old

With our hand-forged slate rippers you effortlessly remove slate nails from overlaps. And flexible, thanks to the asymmetrical positioning of the lateral nail pullers. This is where tradition meets true craftsmanship. Both in the manufacturing of the tool and in its application - roofers love it! And it is available in 6 variants with different working depths. These range from 315 mm to 650 mm. So that you are always well prepared.



**Quality
With A Long
Tradition**



Slate Ripper Stainless Steel

Application

Practical customizer: Removes slate nails from overlaps!



Benefits & Comfort

- Highly flexible: The blade is made of 1.5 mm stainless steel
- Sustainable: The stainless steel blade is replaceable
- Practical: Hand-forged claw handle with integrated nail puller
- Durable and safe: Use of self-locking nuts
- Equal: Extended nail claw without disadvantage for left-handed users



Item no. 00251400

Item no.	Version	Dimensions	Weight	PU
00251315	Slate ripper stainless steel, 2 nail puller	315 mm	900 g	1
00251400	Slate ripper stainless steel, 4 nail puller	400 mm	1 kg	1
00251470	 Slate ripper stainless steel, 4 nail puller	470 mm	1.1 kg	1
00251525	Slate ripper stainless steel, 4 nail puller	525 mm	1.2 kg	1
00251600	Slate ripper stainless steel, 4 nail puller	600 mm	1.3 kg	1

Because extra thin can be extra strong

Because every millimeter counts when working on an overlap. That is why we have designed the stainless steel blade to be extra thin. So you can work precisely and flexibly. You can change the blade easily and mount it securely with the special screws.

Slate Ripper Exchangeable Blade Stainless Steel

Application & Benefits

- Extra thin: 1.5 mm thick
- Highly flexible: Made from special stainless steel
- Durable: Non-rusting
- Complete: With fastening screws and wrench



Item no. 00253400

Handle for Slate Ripper with Nail Claw

Application & Benefits

- Robust: Nail claw forged
- Complete: With fastening screws and wrench
- Equal: Extended nail claw without disadvantage for left-handed users



Item no. 17010

Handle for Slate Ripper Straight Form

Application & Benefits

- Stable: Heavy cast iron
- Ergonomic: Classic handle without nail claw
- Complete: With mounting screws and wrenches



Item no. 17012

Item no.	Version	Dimensions	Weight	PU
00253315	Slate ripper exchange blade stainless steel, 2 nail puller	315 mm	150 g	1
00253400	Slate ripper exchange blade stainless steel, 4 nail puller	400 mm	250 g	1
00253470	Slate ripper exchange blade stainless steel, 4 nail puller	470 mm	250 g	1
00253525	Slate ripper exchange blade stainless steel, 4 nail puller	525 mm	250 g	1
00253600	Slate ripper exchange blade stainless steel, 4 nail puller	600 mm	300 g	1
17010	Handle for slate ripper with nail claw	220 mm	850 g	1
17012	Handle for slate ripper straight form	250 mm	930 g	1

Slate Ripper Straight Handle

Application & Benefits

Practical coordinator:
Removes slate nails from overlaps!

- Highly flexible: The blade is made of 1.5 mm stainless steel
- Sustainable: The stainless steel blade is replaceable
- Handy: Ergonomic steel handle in straight shape



Item no. 00254525

Slate Ripper Spring Steel

Application & Benefits

Rigorous mover:
Removes slate nails from overlaps!

- Highly flexible: The blade is made of 1.5 mm stainless steel
- Sustainable: The stainless steel blade is replaceable
- Handy: Ergonomic steel handle in straight shape



Item no. 00241400

Item no.	Version	Dimensions	Weight	PU
00254525	Slate ripper straight handle, 2 nail puller	525 mm	1 kg	1
00254600	Slate ripper straight handle, 2 nail puller	600 mm	1.1 kg	1
00241315	Slate ripper spring steel, 2 nail puller	315 mm	645 g	1
00241400	Slate ripper spring steel, 4 nail puller	400 mm	700 g	1
00241470	Slate ripper spring steel, 4 nail puller	470 mm	755 g	1
00241525	Slate ripper spring steel, 4 nail puller	525 mm	800 g	1
00241600	Slate ripper spring steel, 4 nail puller	600 mm	840 g	1
00241650	Slate ripper spring steel, 4 nail puller	650 mm	885 g	1

Demolition Tool BOZZ

Application

Big boss: Tears off waterproofing and vapor barrier membranes, shingles and insulation boards!

Benefits & Comfort

- Comfortable: 2K power handle for efficient power transfer from your hand to the tool
- Efficient: Strong toothed blade pulls the nails out very quickly
- Ergonomic and robust: Enormous leverage for little effort. Sliding and lever tube as well as a robust tubular steel handle provide a perfect unit
- Robust: No moving parts, fully welded
- Powerful: Sliding tube ensures optimum feeding
- Fast: 200 mm working width



Item no. 00271000

Item no.	Version	Dimensions	Weight	PU
00271000	Demolition tool BOZZ	1.350 x 200 mm	4.6 kg	1



Because every master needs a good BOZZ

The BOZZ cuts your demolition time in half. Significantly. Gone are the days when you had to tear off roofs with standard shovels and broke yourself in the process. Now there is a new BOZZ on the roofs of this world. Because it is not only durable, but also extremely resilient.

Demolition Tool Little BOZZ

Application

Little boss: Tears off waterproofing and vapor barrier membranes, bitumen shingles, insulation boards up to 100 mm!

Benefits & Comfort

- Comfortable: Plastic handle for easy use
- Efficient: Strong toothed blade pulls the nails very quickly
- Ergonomic: Lever action for little effort
- Robust: No moving parts, fully welded
- Maneuverable: 100 mm working width



Item no. 00270000

Item no.	Version	Dimensions	Weight	PU
00270000	Demolition tool little BOZZ	580 x 100 m	2 kg	1



Because we like to save your time

Because we have designed the small BOZZ so innovatively, that demolition is twice as fast as before. In hard-to-reach corners, the little one comes out big. Thanks to the sturdily drawn tube. For more power and leverage. It is very durable. And extremely resilient.

Demolition Tool BOZZ Set

Application

Perfect team: Tears off waterproofing and vapor barrier membranes, shingles and insulation boards!

Benefits & Comfort

- Powerful BOZZ: 2-component power handle, enormous leverage and 200 mm working width
- Comfortable little BOZZ: 2K handle, leverage and 100 mm working width
- Efficient: Strong toothed blades pull out the nails very quickly
- Robust: no moving parts, fully welded



Item no. 00272000

Item no.	Version	Dimensions	Weight	PU
00272000	Demolition tool BOZZ Set	580 x 100 mm / 1.350 x 200 mm	2 kg / 4.6 kg	1

Set includes:

1 x 00271000 BOZZ, 1 x 00270000 little BOZZ



Because behind every master stands a good team

With the BOZZ Set, you not only reduce your working time in half during demolition, but you are also flexible with the possible applications. While the BOZZ is extremely resilient and offers you an ingenious leverage for even more power, the little BOZZ gets into hard-to-reach corners and effortlessly clears away a lot of stuff.

Lath Lifter

Application

Sturdy strongman: Lifts and tears battens from rafters with a leverage height of 100 millimeters and has a maximum lifting capacity of 120 kilograms!

Benefits & Comfort

- Power-saving: 650 mm long reinforced lever steel tube ensures perfect handling
- Reinforced: In the connection between lever head and lever tube
- Gentle: The rounded lever support makes it easier for you to roll when levering and protects the surface
- Fast: High time savings thanks to the combination of various advantages on the tool
- Robust and durable: No moving parts are used, the tool is fully welded
- Ergonomic: Ribbed PVC handle fits perfectly in your hand



Item no. 00250000

Item no.	Version	Dimensions	Weight	PU
00250000	Lath lifter, claw width 150 mm	760 x 180 mm	2.2 kg	1



Because demolition work must be done quickly

So don't lose any time during demolition! The lath lifter sets the lever perfectly - thanks to the 650 millimeter long steel tube and the PVC handle, which fits perfectly in your hand. Simply remove old battens. Save energy. And time.

Wrecking Bar Heavy Duty

Application

Powerful crusher: Levers, breaks and pulls nails during demolition!



Benefits & Comfort

- Perfect: Oval shape transfers your power better than its round colleagues
- Durable: Thanks to the special hardening process and corrosion-protected surface
- Robust: Forged from one piece
- Gentle on force: With the optimized nail extractor it is easy to pull out flat nails
- Compact: Weight and size in perfect balance



Item no. 00230610

Item no.	Version	Dimensions	Weight	PU
00230610	 Wrecking bar, oval shape	600 x 30 mm	1.8 kg	1
00230910	Wrecking bar, oval shape	900 x 30 mm	3 kg	1

Because you have to get things done quickly

And with this nail breaker you won't let anything go to waste. With it you tear off everything - and always very safely. Especially since you have to use less force and work very ergonomically.

Double utility bar, 380 mm, Particularly Flat

Application & Benefits

**Flat helper: Universal tool
Optimized for the roofer!**

- Flat: Ideal for boards and deep nails
- Stable: Forged from high quality tool steel
- Wide: 35 mm wide lever surface



Item no. 00302000

Flooring crow bar, Handy Version, 250 mm only

Application & Benefits

Small crusher: pulls nails and levers, only 250 mm long!

- Small: Only 250 mm long
- Handy: Fits in every corner and fits in every pocket
- Sturdy: Forged and hardened



Item no. 00301000

Wrecking Bar Angular

Application & Benefits

- Easy to grip: 6-edged shape
- Stable: Forged from high quality tool steel
- Rust-proof: Treated with high quality powder coating



Item no. 00290600

Item no.	Version	Dimensions	Weight	PU
00302000	Double utility bar, particularly flat	380 x 35 mm	700 g	1
00301000	Flooring crow bar, handy version	250 mm	250 g	1
00290600	Wrecking bar, angular	600 mm	1.5 kg	1
00290800	Wrecking bar, angular	800 mm	1.9 kg	1

Slate Lifting Bar

Application & Benefits

- Flat oval
- 20 x 12 mm
- With nail claw and hook



Item no. 00300000

Nail Claw HOOK

Application & Benefits

Handy remover: Pulls nails out comfortably!

- Power-saving: Ideal leverage, ideal for loosening and removing common screws and nails
- Robust and unique: Hand forged
- Comfortable: Ergonomic beech wood handle for good power transmission
- Short and sweet: Fits everywhere



Item no. 00303000

Item no.	Version	Dimensions	Weight	PU
00300000	Slate lifting bar	410 mm	650 g	1
00303000	Nail claw HOOK	260 mm	380 g	1

Rofer's Hammer with Head Protection

Application & Benefits

Robust assistant:
Strikes and pulls nails!

- Robust and safe: Highest safety with head and shaft protection
- Balanced: Tool weight is optimally balanced
- Dynamic: Highest striking force thanks to perfect head weight
- Your choice: With and without magnet



Item no. 00102001

Rofer's Hammer with Reinforced Head Protection

Application & Benefits

Comfortable partner:
Strikes and pulls nails!

- Robust and safe: Highest safety with head and shaft protection and additional reinforcement by a steel ring
- Holding: With nail magnet in the head
- Look: Highly polished head and elegant design



Item no. 00110698

Rofer's Hammer One Piece Forged Steel

Application & Benefits

Balanced friend:
Strikes and pulls nails.
And is easy in the hand!

- Durable: One piece forged steel
- Fatigue-free: Ergonomic 2K soft grip absorbs impact
- Balanced and ultra-light-weight: Tool weight is perfectly balanced



Item no. 00114002

Item no.	Version	Dimensions	Head weight	PU
00102001	Rofer's hammer with head protection, without magnet	320 mm	600 g	1
00112001	Rofer's hammer with head protection, with magnet	320 mm	600 g	1
00110698	Rofer's hammer with reinforced head protection, with magnet	320 mm	600 g	1
00114002	Rofer's hammer one piece forged steel	320 mm	500 g	1

Rofer's Hammer with Leather Handle

Application & Benefits

Strong partner: Strikes and pulls nails. And lies perfectly in the hand!

- Comfortable: High quality, twist-proof leather handle regulates humidity
- Stable and safe: Full steel design ensures highest safety
- Durable: Adjustable steel end cap for retensioning of the leather discs



Item no. 00114000

Rofer's Hammer Freund by Picard Black

Application & Benefits

Strong partner: Strikes and pulls nails. And lies perfectly in the hand!

- Look: With black painted head
- Stable and particularly safe: Steel ring to reinforce the high-quality connection between handle and head and reinforced safety pin
- Fatigue-free: Ergonomic 2K handle absorbs the impact
- Dynamic: Highest striking power thanks to perfect head weight



Item no. 00115000

Rofer's Hammer Freund by Picard Polished

Application & Benefits

Strong partner: Strikes and pulls nails. And lies perfectly in the hand!

- Look: With ground head
- Sturdy and particularly safe: Steel ring to reinforce the high-quality connection between handle and head and reinforced safety pin
- Fatigue-free: Ergonomic 2K handle absorbs the impact
- Dynamic: Highest striking power thanks to perfect head weight



Item no. 00116000

Item no.	Version	Dimensions	Weight	PU
00114000	Rofer's hammer with leather handle	320 mm	700 g	1
00115000	Rofer's hammer Freund by Picard black, roughened track	320 mm	600 g	1
00116000	Rofer's hammer Freund by Picard polished, with magnet, roughened track	320 mm	600 g	1
00116001	Rofer's hammer Freund by Picard blank, with magnet, plain track	320 mm	600 g	1



**Stable,
Safe And
Durable**

Claw Hammer with Leather Handle

Application & Benefits

**Pleasant power converter:
Drives in nails and removes
old ones!**

- Comfortable: High quality, twist-proof leather handle regulates humidity
- Stable and safe: Full steel design ensures highest safety
- Durable: Adjustable steel end cap for retensioning of the leather discs



Item no. 00119001

Mortise Axe

Application & Benefits

**Unique wood artist: To
customize of pin and mortise!**

- High quality: Forged 3-sided ground cutting edge
- Hard: Made from hardened chrome vanadium steel



Item no. 00170450

Chisel

Application & Benefits

**Powerful friend: For
splitting and shaping wood!**

- Durable: High quality forged blade made of hardened chrome-molybdenumsteel
- Impact resistant: The handle is made of tough and impact resistant hornbeam wood and equipped with an impact ring
- Durable: Blade and handle are clear lacquered



Item no. 01430020

Art.-Nr.	Ausführung	Abmessungen	Gewicht	VE
00119001	Claw hammer with leather handle	320 mm	900 g	1
00170450	Mortise axe	450 mm	450 g	1
01430020	Chisel	20 mm	157 g	1
01430022	Chisel	22 mm	185 g	1
01430024	Chisel	24 mm	195 g	1
01430030	Chisel	30 mm	225 g	1

Lath Axe with Soft Handle

Application & Benefits

Universal assistant: Shapes and processes wood and plaster!

- Comfortable: Ergonomic soft grip
- Sharp: Cutting edge precisely ground and hardened
- Safe: Head and handle safety-through reinforced safety pin and additional steel ring
- Universal: For the roofer and the drywall



Item no. 00123000

Hatched With Handle from Ash Wood

Application & Benefits

Handy splitter: Shapes wood where it is needed!

- Compliant: Manufactured according to DIN 5131
- Durable: With ash wood crow bar handle
- Durable cutting: The cutting edge is hardened and precision ground
- Rust-proof: The head is lacquered in gold



Item no. 00180600

Wooden Axe with Handle from Ash Wood

Application & Benefits

Powerful splitter: Shapes the wood, when striking power is needed!

- Compliant: Manufactured according to DIN 5131
- Durable: With ash wood crow bar handle
- Durable cutting: The cutting edge is hardened and precision ground
- Rust-proof: The head is lacquered in gold



Item no. 00181250

Item no.	Version	Dimensions	Weight	PU
00123000	Lath axe with soft handle	325 mm	700 g	1
00180600	Hatched with handle from ash wood	360 mm	600 g	1
00181250	Wooden axe with handle from ash wood	800 mm	1.2 kg	1

Roof Tile Cutter Bibermax

Application

Sharp crusher: Scribes and breaks beaver tail tiles highly precise up to 400 mm length!

Benefits & Comfort

- Dust-free: Thanks to precise scribing and breaking of the beaver-tail tiles
- Wireless and low-noise: Processing of the beaver-tail tiles without the need for an engine
- Convenient: Use on flat as well as inclined surfaces, thanks to angle adjustment in four locking positions
- Firm and safe: Two adjustable hook-in devices (up to 45 mm roof batten thickness) and safety rope made of plastic-coated steel
- Flexible: Can be used for different tile thicknesses thanks to variable tensioning mechanism



Item no. 00260000

Item no.	Version	Dimensions	Weight	PU
00260000	Roof tile cutter Bibermax with roof support and guide, cutting length 400 mm	730 x 300 mm	15.2 kg	1
Spare part:				
17802	Special carbide wheel	Ø 14 mm	4 g	1
17803	Handle with special carbide wheel	200 mm	50 g	1



Because power also works without electricity

Off the roof to cut beaver tail tiles? No way. You simply hang the Bibermax in the roof. It works powerfully, precisely and dust-free. And it does not need a power connection. The guide gives you the additional flexibility you need to make a wide variety of cuts.

Tile Nibbler Forged

Application

Black lightning: Shapes roof tiles and shortens wire up to 2.5 millimeters in diameter!

Benefits & Comfort

- Simple: The handy format can be used very quickly
- Robust and durable: The cutting edges are inductively hardened
- Practical: Polished head with 55 mm jaws



Item no. 00211000

Item no.	Version	Jaw opening	Dimensions	Weight	PU
00211000	Tile nibbler, forged	55 mm	220 x 50 mm	455 g	1



Because some things are simple irreplaceable

Because the tile nibbler belongs to any equipment. They are specially designed for roof tiles and inductively hardened. Power meets function: You can open the pliers mouth up to 55 millimeters wide.

Roof Tile File

Application & Benefits

- Durable: Carbide coated
- Useful: For clean edge breaking on all types of bricks
- Universal: One rough, one smooth face



Item no. 01381000

Item no.	Version	Dimensions	Weight	PU
01381000	Roof tile file	200 mm	230 g	1

Tile Drill

Application & Benefits

- The high performance drill enable dry drilling of the hardest bricks
- Asymmetric spiral shape
- Chip removing
- Ungsten-titanium tip
- Burnished surface



Item no. 01561000

Universal Drill Goldcraft

Application & Benefits

- Special cutting geometry
- Asymmetric spiral shape
- Chip removing
- Ground surface



Item no. 01565000

Hammer Drill SDS-Plus

Application & Benefits

- Made of chrome-nickel-molybdenum steel
- Sandblasted and intermediate stage hardened
- Center point



Item no. 01571200

Item no.	Version	Dimensions	Weight	PU
01561000	Tile drill, 5 pieces	5 x 85 mm	50 g	1
01563000	Tile drill, 1 piece	5 x 85 mm	10 g	1
01564000	Tile drill, 1 piece	6 x 100 mm	10 g	1
01565000	Universal drill goldcraft, 1 piece	5 x 85 mm	10 g	1
01566000	Universal drill goldcraft, 1 piece	4 x 75 mm	10 g	1
01571200	Hammer drill sds-plus, 1 piece	6 x 110 mm	10 g	1
01571300	Hammer drill sds-plus, 1 piece	6 x 160 mm	10 g	1

A close-up photograph of a blue-painted metal mechanical component, possibly a hinge or a pivot point, mounted on a red surface. The component features a cylindrical part with a textured finish and a smaller cylindrical protrusion with a central hole. The background is a blurred red surface, and a green and blue object is partially visible on the left edge.

**Flexible,
Comfortable
And Safe**

Cutting
Reimagined

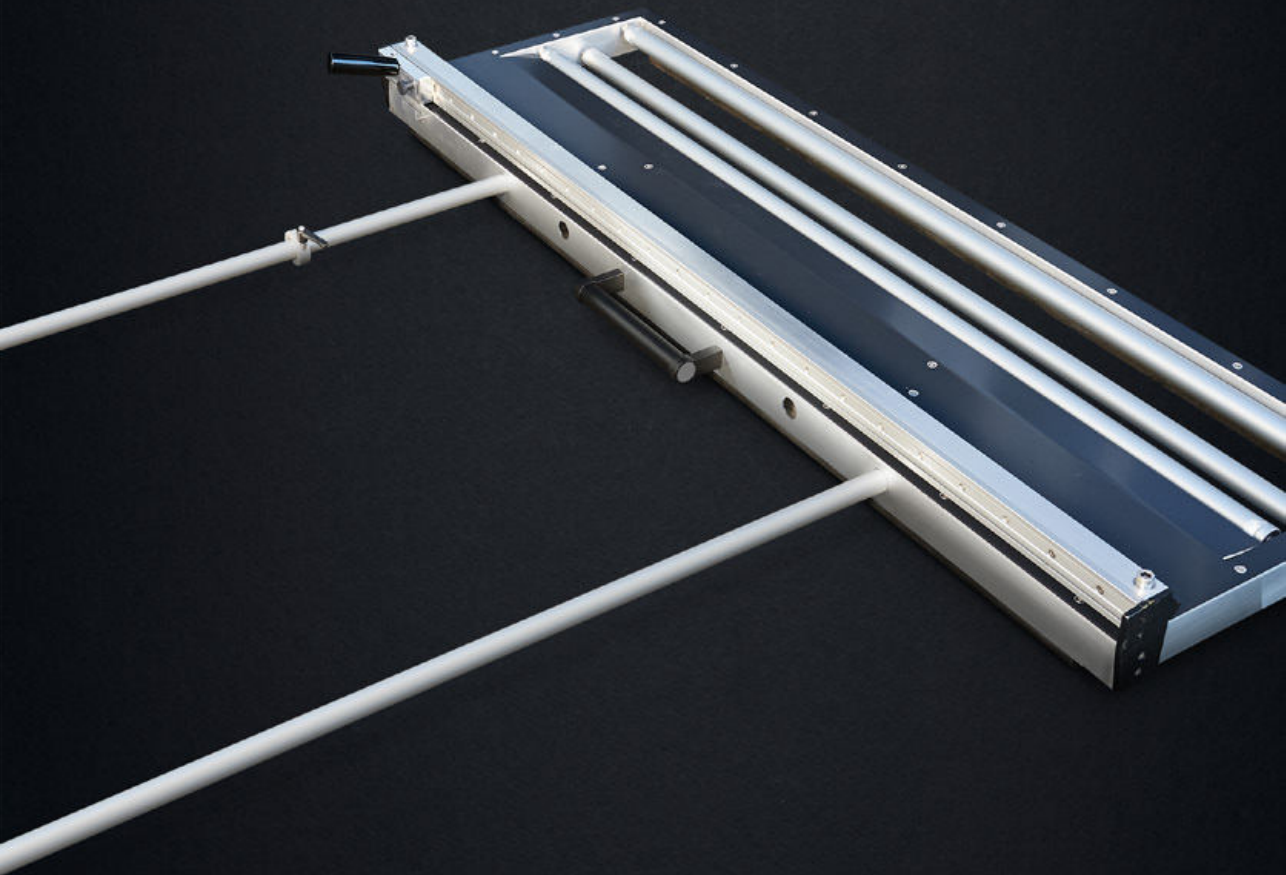



Bitumencutter Bitumen Pro

by biegetec

New

Only one click away.
Integrated click function
from the item image to
our webshop.



Application

Precise perfectionist: Cuts bitumen sheets precisely, the same way every time, and really fast!



Benefits & Comfort

- Accurate: Makes perfect straight cuts
- Time-saving: No more marking, but faster cutting than by hand
- Flexible: Quickly adjust and perform changing cuts
- Light and handy: Made of aluminum, weight less than 15 kg
- Space-saving: Many cuts can be made without unrolling the roll completely
- Safe: No more risk of slipping, as the robust blade is guided automatically
- Compatible: Standard hook blades are used
- Universal: Suitable for bitumen and PVC and FPO membranes up to 1250 mm wide



Item no. 03380000

Item no.	Version	Working width	Dimensions	Weight	PU
03380000	Bitumencutter Bitumen Pro	1.250 mm	1.430 x 460 x 135 mm	14.95 kg	1



Because you really get it tight with it

If you regularly cut the heavy bitumen sheets and change the cuts frequently, you want to save time and play it safe at the same time - for your team and for the roof itself. The Bitumen Pro is the perfect tool for this.



**Comfort,
Safety And
Precision**

Silicon Pressure Roller Smooth-Running Ball Bearings

Application

Fine roll: For seam joining during overlap welding of high polymer roofing and sealing membranes!



Freund
Choice



Smooth Running
Ball Bearings

Benefits & Comfort

- Keeps track: Two enclosed smooth-running ball bearings ensure perfect rolling
- Transferring: Short distance between the silicone roller and the handle and the central position of the roller in front of the handle ensures perfect power transmission without detours and at the same time protects the wrist
- Comfortable: Finger recess in the handle ensures optimal handling
- Works very precisely: Axles and components are finely adjusted and screwed together



Item no. 04222045

Item no.	Version	Dimensions	Weight	PU
04222028	 Silicon pressure roller smooth-running ball bearings	28 mm	155 g	1
04222045	Silicon pressure roller smooth-running ball bearings	45 mm	190 g	1



Because gentle always pays off

Because it is easy on the wrist when working, especially. In the long term. The perfect handle design also ensures this. The silicone roller compensates for the slightest unevenness in the in the surface. It is highly elastic and temperature-resistant.

ErgoWheel® Pressure Roller Smooth-Running Ball Bearings

Application

Rock'n'Roller: For seam joining during overlap welding of high polymer roofing and sealing membranes!



Benefits & Comfort

- Easy on the joints: Thanks to innovative handle design
- Powerful: Handle centered above the roller applies the power and at the same time protects the wrist
- Comfortable: Ergonomic handle fits perfectly in the hand
- Stays on track: Two closed smooth running ball bearings for perfect rolling performance
- Works very precisely: Axles and components are finely adjusted and screwed

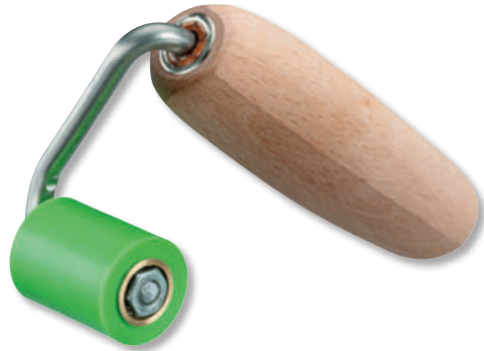

Item no. 04210045

Item no.	Version	Dimensions	Weight	PU
04210045	Ergowheel® pressure roller, smooth-running ball bearings, right	45 mm	230 g	1
04211045	Ergowheel® pressure roller, smooth-running ball bearings, left	45 mm	230 g	1

Because ergonomics simply comes first

And the ErgoWheel® offers it. With it you make meter after meter without using more force. That's how gentle works. It compensates for the smallest unevenness in the ground. Its silicone roller is highly elastic and temperature-resistant. For high-precision work and the best results.

Silikon-Pressure Roller Wide, Bush Bearings

Application & Benefits

Wide roller: For seam joining in overlap welding!

- Precise: Axles and components are finely adjusted and screwed together
- Comfortable: Finger recess in the handle ensures ideal handling
- Powerful: Handle in front of the roller transfers the power ideally and at the same time protects the wrist



Bush Bearings



Item no. 04220090

Silikon-Pressure Roller Bush Bearings

Application & Benefits

Proven roller: For seam joining for overlap welding!

- Precise: Axles and components are finely adjusted and screwed together
- Comfortable: Finger recess in the handle ensures ideal handling
- Powerful: Handle in front of the roller transfers the power ideally and at the same time protects the wrist



Bush Bearings



Item no. 04221045

Silikon-Pressure Roller Angled

Application & Benefits

Precise corner roller: Ideal for wall connections!

- Variable: Comes through the 30° angled head into every corner
- Comfortable: Finger recess in the handle ensures optimum handling
- Smooth running: Use of 2 smooth-running ball bearings
- Precise: Axles and components are finely adjusted and screwed together



Smooth Running Ball Bearings



Item no. 04224045

Item no.	Details	Dimensions	Weight	PU
04220090	Silicon pressure roller wide, bush bearings	90 mm	350 g	1
04221028	Silicon pressure roller bush bearings	28 mm	165 g	1
04221045	Silicon pressure roller bush bearings	45 mm	250 g	1
04224045	Silicon pressure roller smooth-running ball bearings, 30° angled	45 mm	240 g	1

Pressure Roller Metall Smooth-Running Ball Bearings

Application

Precise track holder: Perfect for joining seams during the overlap welding of roofing and waterproofing membranes!



Friend
Choice



Smooth Running
Ball Bearings

Benefits & Comfort

- Keeps on track: Two closed ball bearings ensure perfect rolling
- Transfers power well: The handle with recessed grip sits centrally in front of the roller
- It is temperature-independent: Special construction and galvanized roller - for work in hot and cold conditions
- Works very precisely: Axles and components are finely adjusted



Item no. 03170040

Item no.	Version	Dimensions	Weight	PU
03170040	 Pressure roller metall smooth-running ball bearings	40 mm	450 g	1
03170060	Pressure roller metall smooth-running ball bearings	60 mm	625 g	1



Because a little pressure never hurts

So that it is not on the hand, the handle is perfectly designed. And the smooth-running ball bearing ensures that everything is all-right and rolls perfectly. And it has to, because the pressure roller is indispensable for seam joining for overlap welding of roofing and waterproofing membranes - also with solvent welding materials.

Pressure Roller Metall Roll Ball Bearings

Application & Benefits

Narrow problem solver:
Ideal for particularly narrow
filled weld situations!

- Applying pressure: High contact pressure due to narrow metal wheel
- Durable: Solid mounting bracket made from one piece
- Smooth running: Through use of smooth-running ball bearings



Smooth Running
Ball Bearings



Item no. 04225000

Pressure Roller Brass Roll Ball Bearings

Application & Benefits

Angled problem solver:
Ideal for particularly narrow
filled weld situations!

- Applying pressure: High contact pressure due to narrow metal wheel
- Durable: Solid mounting bracket made from one piece
- Smooth running: Through use of smooth-running ball bearings



Smooth Running
Ball Bearings



Item no. 04226000

Item no.	Version	Dimensions	Weight	PU
04225000	Pressure roller metall roll smooth-running ball bearings	35 x 6 mm	195 g	1
04226000	Pressure roller brass roll smooth-running ball bearings	28 x 6 mm	145 g	1

Pressure Roller PTFE Non-Stick Smooth-Running Ball Bearings

Application

Sturdy power pack: Perfect for seam joining during the overlap welding of roofing and waterproofing membranes!



Friend
Choice



Smooth Running
Ball Bearings

Benefits & Comfort

- Powerful: Handle with finger recess in front of the roller transfers the force ideally
- Stable and durable: Metal retaining ring, integrated into the wooden handle, ensures high contact pressure
- Smooth running: Due to double smooth-running ball bearings
- Easy to grip: Due to textured surface



Item no. 04229045

Item no.	Version	Dimensions	Weight	PU
04229028	Pressure roller PTFE non-stick smooth-running ball bearings	28 mm	165 g	1
04229045	 Pressure roller PTFE non-stick smooth-running ball bearings	45 mm	200 g	1

Because power is transferred perfectly

Because this roller generates an extremely high contact pressure. At the same time, it is very easy to guide, thanks to the textured rolling surface and the material used. The PTFE also makes the roller easy to clean and heat-resistant.

Fillet Weld Slide PTFE Non-Stick

Application

Ingenious addition: For seam joining in fillet welding situations - when the pressure roller is not sufficient!

Benefits & Comfort

- Universal: Special head design with radius at the pressure edge and rounding on one side - for detailed work in corners and corners with a high level of detail
- Ergonomic and safe: 2K handle with finger recess fits perfectly in the hand
- Heat-resistant: Durable head made of PTFE, which does not stick to the material



Item no. 04232040

Item no.	Version	Dimensions	Weight	PU
04232040	Fillet weld slide PTFE non-stick	45 mm	110 g	1



Because the tension must be held

And this slider minimizes stress cracks due to the small radius and the rounded corners. If liquid plastics are used, you can use it to place the fleece optimally in fillet situations. Also convenient: It can be cleaned very well due to its non-stick characteristics.

Seam Tester 90° Angled

Application

Pointed inspector: Checks the welded seam of the roofing and sealing membrane for defects!

Benefits & Comfort

- Gentle and safe: Simply check seams with rounded cone tip
- Ergonomic: Wooden handle ensures perfect handling
- Quick and easy: Angled tool tip for easy testing



Item no. 04231000

Item no.	Version	Dimensions	Weight	PU
04231000	Seam tester 90° angled	240 x 50 mm	110 g	1

Because quality control is part of the job

And with the seam tester, you can find possible flaws without damaging the material. The tool works gently without creating new holes. At the same time, you work very ergonomically.



**Gentle,
Safe and
Ergonomic**

Flat Roof Starter Kit

Application & Benefits

The starter set contains the 11 most common tools for the professional installation of roofing and sealing membranes!



Item no. 04229999

Item no.	Version	Dimensions	Weight	PU
04229999	Flat roof starter kit, 12-piece	330 x 150 x 150 mm	3.1 kg	1
Included in the set:				
45174000	Tool box, small	450 x 260 x 224 mm	1.2 kg	1
02030000	Shark knife with retractable blade	160 x 45 mm	190 g	1
02300100	Trapezoidblades "Made in Solingen", 10 blades	70 mm	40 g	1
02310100	Hookedblades "Made in Solingen", 10 blades	70 mm	40 g	1
04222028	Silikon-pressure roller, smooth-running ball bearings	33 x 28 mm	155 g	1
04222045	Silikon-pressure roller, smooth-running ball bearings	33 x 45 mm	240 g	1
03170040	Pressure roller metall	40 x 40 mm	450 g	1
04226000	Pressure roller brass roll	28 x 6 mm	145 g	1

It's all in there



Item no. 02030000



Item no. 02300100



Item no. 02310100



Item no. 04222028



Item no. 04222045



Item no. 03170040



Item no. 04226000



Item no. 04231000



Item no. 02710250



Item no. 03403500



Item no. 03402501

Item no.	Version	Dimensions	Weight	PU
04231000	Seam tester	250 mm	200 g	1
02710250	Foil scissors with soft handle	250 mm	360 g	1
03403500	Plastic bottle	500 ml	70 g	1
03402501	Brush attachment for plastic bottle, cranked	1 1/2"	35 g	1

Flat Roof Starter Kit with Ergowheel®

Application & Benefits

The starter set contains the 12 most common tools for the professional installation of roofing and sealing membranes!



Item no. 04229990

Item no.	Version	Dimensions	Weight	PU
04229999	Flat roof-starter kit with Ergowheel®, 13 pieces	330 x 150 x 150 mm	3.5 kg	1
Included in the set:				
45174000	Tool box, small	450 x 260 x 224 mm	1.2 kg	1
02030000	Shark knife with retractable blade	160 x 45 mm	190 g	1
02300100	Trapezoidblades "Made in Solingen", 10 blades	70 mm	40 g	1
02310100	Hookedblades "Made in Solingen", 10 blades	70 mm	40 g	1
04210045	Pressure roller Ergowheel®, right	33 x 45 mm	230 g	1
04222028	Silikon-pressure roller, smooth-running ball bearings	33 x 28 mm	155 g	1
04222045	Silikon-pressure roller, smooth-running ball bearings	33 x 45 mm	240 g	1
03170040	Pressure roller metall	40 x 40 mm	450 g	1

It's all in there



Item no. 02030000



Item no. 02300100



Item no. 02310100



Item no. 04210045



Item no. 04222028



Item no. 04222045



Item no. 03170040



Item no. 04226000



Item no. 04231000



Item no. 02710250



Item no. 03403500



Item no. 03402501

Item no.	Version	Dimensions	Weight	PU
04226000	Pressure roller brass roll	28 x 6 mm	145 g	1
04231000	Seam tester	250 mm	200 g	1
02710250	Foil scissors with soft handle	250 mm	360 g	1
03403500	Plastic bottle	500 ml	70 g	1
03402501	Brush attachment for plastic bottle, cranked	1 1/2"	35 g	1

Roofing Membrane Roller Winding Core

Application

Rock'n Roller: Helps to unroll roofing membranes, especially bitumen!



Benefits & Comfort

- Great protection: Due to the opening along the entire length of the roller, the overlay can be placed centrally ensuring an overlap at both ends
- Practical: Easy positioning through the funnel shaped opening and a controlled, easy and quick unrolling
- Sturdy and heat resistant: Because of the aluminum core, the contact pressure is distributed evenly over the entire length
- Handy: Lightweight tool



Item no. 04240000

Item no.	Version	Dimensions	Weight	PU
04240000	Winding Core	60 x 950 mm	1.5 kg	1



Because a power pack can be light

And because the winding core makes it easy for you: Threading the roll is very easy. The contact pressure is ideal, making it very ergonomic to work with. The tool can also withstand heat well and also offers good protection.

Foil Scissors Sturdy Metal Design

Application

Sharp long-duration cutter: For durable cutting of foils and high-polymer roofing membranes!



Benefits & Comfort

- Powerful: Precision grinding for best cuts
- Stable: Due to torsion-resistant blades
- Long-lasting: The crown screw can be readjusted, the hardened blades with handle are forged from one piece
- Ergonomic: Special handle for fatigue-free work



Item no. 02720250

Item no.	Version	Dimensions	Weight	PU
02720250	 Foil scissors, sturdy metal design	260 x 90 mm	400 g	1

Because good cuts make the difference

Precise cutting, even over longer distances, and you like to do it fast? Nothing could be easier. Because the very long cutting length makes it possible. What's more, the scissors cut right to the tip of the blade. The ergonomic handle simplifies the whole thing even more.

Foil Scissors with Soft Handle Original Finny

Application & Benefits

Separating assistant:
Good workmanship makes these scissors a classic!

- Cutting: Blade quality "Made in Solingen"
- Comfortable: 2-component soft handles, suitable for right- and left-handers
- Precise: Finely shaped cutting edges for precise work



Item no. 02730200

Foil Scissors with Soft Handle

Application & Benefits

Lightweight separator:
These scissors impress by their handiness!

- Handy: Lightweight and precise cutting
- Durable: Scissors made of stainless steel
- Comfortable: 2-component soft grips



Item no. 02710250

Plastic Bottle with Drip Cap

Application & Benefits

Precise dispenser:
For ideal application of liquids!

- LDPE bottle
- Transparent material with drip cap



Item no. 03400250

Item no.	Version	Dimensions	Weight	PU
02730200	Foil scissors with soft handle, original finny, blue	200 mm	90 g	1
02730250	Foil scissors with soft handle, original finny, red	250 mm	110 g	1
02710250	Foil scissors with soft handle	250 mm	110 g	1
03400250	Plastic bottle with drip cap	250 ml	30 g	1
03400500	Plastic bottle with drip cap	500 ml	45 g	1

Bottle With Brush for Solvent Welding Material

Application & Benefits

Precise dispenser: Bottle with brush for precise dispensing of solvent welding material!

- Consistent: Precisely manufactured brass nozzle
- Durable: High quality connection of brush and cap, bonded and molded
- Dosable: Flexible LDPE plastic bottle and high quality China bristles



Item no. 03402250/03401250

Bitumen Roller Heat Resistant up to 160° C

Application & Benefits

Heat resistant distributor: Universal roller, suitable for hot bitumen!

- Heat resistant up to 160° C: Due to metal holder and cover made of perlon
- Durable: Riveted continuous brass sleeve



Item no. 03371000

Universal Double Bracket Heat Resistant

Application & Benefits

Universal bracket: Fits all common roll sizes!

- Handy: Infinitely adjustable double handle and suitable for all common roll sizes
- Equal: Guide on both sides ensures for even contact pressure
- Heat resistant: Made entirely of metal



Item no. 03370000

Item no.	Version	Dimensions	Weight	PU
03401250	Plastic bottle with brush attachment, straight	250 ml	60 g	1
03401500	Plastic bottle with brush attachment, straight	500 ml	80 g	1
03402250	Plastic bottle with brush attachment, cranked	250 ml	60 g	1
03402500	Plastic bottle with brush attachment, cranked	500 ml	80 g	1
03401501	Brush attachment for plastic bottle, straight	1 1/2"	35 g	1
03402501	Brush attachment for plastic bottle, cranked	1 1/2"	35 g	1
03371000	Bitumen roller, heat resistant up to 160°C	250 mm	135 g	1
03370000	Universal double bracket, heat resistant	250 mm	350 g	1

Combi-Roller Solvent Resistant

Application & Benefits

- Universal: For liquid plastics, coatings and primers
- Robust: Solvent resistant
- Soft and absorbent: Polyamide thermofused with a pile height of 13 mm



Item no. 03372000

Spindel Roller for Combination Roller

Application & Benefits

- Universal: System 6 mm, suitable for combination roller
- Handy: Ergonomic handle
- Rust-proof: Made from galvanized steel



Item no. 03373100

Paintbrush Bent Long Wooden Handle

Application & Benefits

- Apply evenly: Bristles are conical in shape and become thinner towards the tip. The bristle tip is split into several fibers
- Qualitative: Pure China bristles
- Angled: Due to the angled bristle trim and the handle, the brush is ideally suitable for corners and joints



Item no. 03360001/03360003

Item no.	Version	Dimensions	Weight	PU
03372000	Combi-roller, solvent resistant, small	100 mm x Ø 30 mm	35 g	1
03373000	Combi-roller, solvent resistant, big	250 mm x Ø 48 mm	130 g	1
03373100	Spindel roller for combination roller	100 mm	120 g	1
03373001	Spindel roller for combination roller	250 mm	150 g	1
03360001	Paintbrush 1,5", bent, long woodenhandle	65 x 90 x 435 mm	45 g	12
03360003	Paintbrush 3", bent, long woodenhandle	80 x 95 x 550 mm	90 g	12

Paintbrush Straight Short Wooden Handle

Application & Benefits

- Apply evenly: Bristles are conical in shape and become thinner towards the tip. The bristle tip is split into several fibers
- Qualitative: Pure China bristles
- Handy: Short handle made of natural wood



Item no. 03350001/03350003

Water Dozer Hard Rubber

Application & Benefits

Universal dozer: Removes water and spreads liquid materials!

- Abrasion resistant: Wiper consists of a 5 mm thick hard rubber lip, which cannot become soaked
- Overhanging: Rubber lip protects upstanding components
- Long-lasting: 25 mm high, stable and corrosion-protected guide rail



Item no. 01860600

Water Dozer Foam Rubber

Application & Benefits

Universal dozer: Removes water and spreads liquid materials!

- Applying: Whatever needs to be spread - the foam rubber wiper is ideal
- Overhanging: Rubber lip protects upstanding components
- Comfortable: Double foam rubber lip with 20 mm thickness and 450 mm or 550 mm working width



Item no. 01870450

Item no.	Version	Dimensions	Weight	PU
03350001	Paintbrush 1,5", straight, short wooden handle	60 x 75 x 210 mm	18 g	12
03350002	Paintbrush 2", straight, short wooden handle	80 x 75 x 210 mm	12 g	12
03350003	Paintbrush 3", straight, short wooden handle	80 x 120 x 235 mm	46 g	12
01860600	Water dozer, hard rubber	550 mm	700 g	1
01870450	Water dozer, foam rubber	450 mm	245 g	1
01870550	Water dozer, foam rubber	550 mm	305 g	1
01860001	Wooden handle for water dozer hard rubber und water dozer foam rubber	1200 mm	560 g	1

Hammer Tacker Freund Fast & Fix F11

Application

Handy assistant: For fixing of underlayments, membranes and foils!



Benefits & Comfort

- Solid: The clamp slider is permanently installed and cannot pop out
- Gentle: Impact plate prevents tearing of the material during fastening
- Ergonomic: With soft-touch handle and shock-free design
- Transparent: Everything is in view - reload indicator is very clearly visible
- Time-saving: Staple magazine with quick opener for 2 staple strips
- Fixing: For staples (flat wire) 11/6 - 11/12 mm



Item no. 01741911

Item no.	Version	Dimensions	Weight	PU
01741911	Hammer tacker Freund Fast & Fix F11 for staples (flat wire) 11/6 - 11/12	300 x 70 mm	960 g	1
Accessories:				
01741011	Staples flat wire 11/10 (package contains 5.000 pieces)	100 mm	675 g	1

Because premium quality has many advantages for you

You have a lot to tack? Then we would like to introduce you to our premium model: Non-rebound, reload indicator and quick opener are just a few of its strengths. It is robustly and durably built and easy to use. Very practical: We deliver the hammer tacker to you with a sturdy belt pouch.

Hammer Tacker FREUND 19

Application

Powerful fastener: For fixing underlays, membranes and foils!



37/6 mm
Roundwire

Benefits & Comfort

- Gentle and power-saving: Lightweight and stable design
- Fast and easy: Reloading with practical top loading mechanism
- Convenient: The flexible knife ejector ensures less staple jams
- Ergonomic: Simple and gentle handling due to soft-touch handle
- Durable: Thanks to robust, high-quality all-steel and flexible knife ejector
- Fixing: For staples (round wire) 37/4 - 37/6 mm



Item no. 01741119

Item no.	Version	Dimensions	Weight	PU
01741119	Hammer tacker Freund 19 for staples (round wire) 37/4 - 37/6	280 x 45 mm	415 g	1
Accessories:				
01741019	Staples round wire 37/6 (package contains 5.000 pieces)	80 mm	225 g	1

Because a stapler doesn't have to be heavy

You have a lot to tack? The lightweight hammer tacker Freund 19 makes it easy for you to fix the different sheets. Thanks to the sturdy construction, it will last for a long time!

Hammer Tacker FREUND 11

Application & Benefits

Valued assistant:
For the fixation of underlays
and foils!

- Durable: Thanks to proven mechanics in high-quality steel design and flexible knife ejector
- Convenient: The flexible knife ejector holds staples permanently and ensures less staple jams
- Fixing: For staples (flat wire) 11/6 - 11/10 mm



11/10 mm
Flatwire



Item no. 01741111

Hammer Tacker RAPID 11

Application & Benefits

Practical assistant:
For the fixing of underlays
and foils!

- Fixing: For the fastening of foils and roofing felt
- Fixing: For staples (flat wire) 11/6 - 11/10 mm



11/10 mm
Flatwire



Item no. 01740011

Hammer Tacker RAPID 19

Application & Benefits

Handy assistant:
For the fixing of underlays
and foils!

- Fixing: For the fastening of foils and roofing felt
- Fixing: For staples (round wire) 37/4 - 37/6 mm



37/6 mm
Roundwire



Item no. 01740019

Item no.	Version	Dimensions	Weight	PU
01741111	Hammer tacker Freund 11 for staples 11/6 - 11/10	300 mm	950 g	1
01740011	Hammer tacker Rapid 11 for staples 11/6 - 11/10	300 mm	850 g	1
01740019	Hammer tacker Rapid 19 for staples 37/4 - 37/6	260 mm	350 g	1

Hammer Tacker RAPID 54

Application & Benefits

Heavy duty fastener: For fastening particularly heavy building materials!

- Heavy: For fastening of heavy foils and roofing felt
- Fixing: For staples (flat wire) 11/8 - 11/14 mm



11/14 mm
Flatwire



Item no. 01740054

Hammer Tacker FREUND 53

Application & Benefits

Precise fastener: Indispensable for the exact fastening!

- Comfortable: Ergonomic 2-component handle made of plastic and metal
- Adjustable: Contact pressure is continuously adjustable
- Fixing: For staples (round wire) 37/6 - 37/16 mm



37/6 mm
Roundwire



37/8 mm
Roundwire



Item no. 01740053

Hammer Tacker RAPID 23

Application & Benefits

Classic fastener: Indispensable for accurate fastening!

- Durable: Made entirely of metal
- Fixing: For staples (round wire) 37/4 - 37/8 mm



37/6 mm
Roundwire



37/8 mm
Roundwire



Item no. 01740023

Item no.	Version	Dimensions	Weight	PU
01740054	Hammer tacker Rapid 54 for staples 11/8 - 11/14	310 mm	1.1 kg	1
01740053	Handtacker Freund 53 for staples 37/6 - 37/16	170 mm	740 g	1
01740023	Handtacker Rapid 23 for staples 37/4 - 37/8	175 mm	525 g	1

Staples Round Wire 37/6

Application & Benefits

Important accessory:
For fastening of underlays
and foils!

- Time-saving: No downtime due to optimal adjustment of the staples to the knife ejector of the tacker
- Convenient: Easy removal thanks to ideal packaging
- Long-lasting: Due to durable bonding of the round wire staples



37/6 mm
Roundwire



Item no. 01741019

Staples Round Wire 37/8

Application & Benefits

Important accessory:
For fastening of underlays
and foils!

- Time-saving: No downtime due to optimal adjustment of the staples to the knife ejector of the tacker
- Convenient: Easy removal thanks to ideal packaging
- Long-lasting: Due to durable bonding of the round wire staples



37/8 mm
Roundwire



Item no. 01760008

Item no.	Version	Dimensions	Weight	PU
01741019	Staples round wire 37/6	80 mm	225 g	1
01760008	Staples round wire 37/8	80 mm	285 g	1

Staples Flat Wire 11/10

Application & Benefits

Important accessory:
For fastening of underlays
and foils!

- Stapling: Thanks to the large contact surface, the wide flat wire staples fix the sheet to be processed better than round wire staples
- Time-saving: No downtime due to ideal bonding of the staple strips



11/10 mm
Flatwire



Item no. 01741011

Staples Flat Wire 11/14

Application & Benefits

**Fixed utensil: For underlays
and foils with 14 mm depth!**

- Stapling: Thanks to the large contact surface, the wide flat wire staples fix the sheet to be processed better than round wire staples
- Time-saving: No downtime due to ideal bonding of the staple strips



11/14 mm
Flatwire



Item no. 01750014

Item no.	Version	Dimensions	Weight	PU
01741011	Staples flat wire 11/10	100 mm	675 g	1
01750014	Staples flat wire 11/14	100 mm	880 g	1

Shark Knife with Retractable Blade

Application

Universal cutting master: Cuts a wide variety of materials!

Benefits & Comfort

- Fast: Blade change in seconds with a simple push of a button
- Ergonomic: The 2K soft handle with recessed grip fits perfectly in the hand
- Robust: Tool made of solid zinc die casting
- Adjustable: 3-stage blade feed for flexible cutting depth
- Razor-sharp: High-performance blade for clean, easy cutting



Item no. 02030000

Item no.	Version	Dimensions	Weight	PU
02030000	Shark knife with retractable blade	160 x 45 mm	190 g	1



Because you need a shark in your team

Two in one: With this high-quality, super-sharp knife, you can cut without extending the blade. The blade can be changed at the touch of a button - fast and simple. And thanks to the storage compartment the blades are always on hand.

Professional Cutter Plus made of Die-Cast Metal

Application

**Perfect professional: Cuts
a wide variety of materials!**

Benefits & Comfort

- Robust and durable: Tool made of solid die-cast metal
- Ergonomic: The 2K soft grip fits perfectly in the hand
- Comfortable: Operation with only one hand. The blade can be locked automatically
- Simple and fast: Change blade with sturdy break-off and change slide
- Smooth running: High-quality metal blade guide
- Sharp: High-performance blade for clean, easy cutting



Item no. 02060001

Item no.	Version	Dimensions	Weight	PU
02060001	Professional cutter plus made of die-cast metal	160 x 40 mm	135 g	1

Because a certain sharpness does not hurt

And this high-quality cutter knife brings you exactly the quality you need for cutting. And you know it when you take the knife in your hand.

Universal Knife Fixed Blade

Application & Benefits

Robust cutter: Fixed blade perfectly locked!

- Simple and robust: Knife in durable zinc die-cast design with fixed blade
- Easy to grip: Due to ribbing in the handle
- Ergonomic: Due to adapted hand shape and thumb rest
- Practical: Blade reservoir in the handle



Item no. 02040000

Universal Knife with Retractable Blade

Application & Benefits

Classic cutter: Robust, durable and with blade feed!

- Simple and safe: Knife in durable zinc die-cast construction with multi-stage retractable blade
- Ergonomic: Due to adapted hand shape and thumb rest
- Practical: Blade storage in the handle



Item no. 02080000

Universal Knife Curved, Fixed Blade, 5 Blades

Application & Benefits

Curved cutter: Due to the curved shape you can transmit more force!

- Powerful: Best power transfer due to curved handle
- Simple and robust: Knife in durable zinc die-cast construction with fixed blade
- Ergonomic: Due to adapted hand shape and thumb rest
- Practical: Blade storage in the handle with 5 trapezoidal blades



Item no. 02550000

Item no.	Version	Dimensions	Weight	PU
02040000	Universal knife, fixed blade, without blades	140 mm	55 g	1
02041000	Universal knife, fixed blade, with 5 blades	140 mm	65 g	1
02080000	Universal knife with retractable blade	160 mm	150 g	1
02550000	Universal knife curved, fixed blade, 5 blades	165 mm	135 g	1

Silver-Knife with Retractable Blade and Quiver

Application & Benefits

Practical cutter: Blade change through snap-open mechanism!

- Simple: Knife is completely opened for blade change
- Safe: With retractable blade and quiver
- Unique: Holder for screwdriver bits
- Comfortable: Pleasant soft grip



Item no. 02110000

BIKO-Knife with Fixed Blade

Application & Benefits

Convenient cutter: With magnetic blade holder!

- Simple: Knife is completely opened for blade change
- Powerful: Good power transfer due to special shape of the soft handle
- Practical: Magnetic support of the blade holder



Item no. 02056000

Professional Cutter with Break-Off Blades

Application & Benefits

Lightweight cutter: Lightweight cutter for break off blades with metal guide!

- Light: Weighs only 48 g
- Safe: Metal guide for break off-blades
- Firm: Blade lock on the blade slider



Item no. 02060000

Item no.	Version	Dimensions	Weight	PU
02110000	Silver-Knife with retractable blade and quiver	185 mm	340 g	1
02056000	BIKO-Knife with fixed blade	170 mm	210 g	1
02060000	Professional cutter with break-off blades	160 mm	48 g	1

Professional Cutter Premium with Auto- matic Feeding System

Application & Benefits

Special cutter: Automatic feeding system of the blades in the storage compartment!

- Infinite: Since the knife holds 3 blades in the automatic feeding system, there is no need to change blades during work
- Safe: Metal blade guide and automatic blade lock
- Comfortable: High-quality mechanics and comfortable 2K soft grip



Item no. 02060002

Comfort Knife Foldable

Application & Benefits

Foldable friend: Robust professional knife in a handy shape!

- Doubly safe: Thanks to the self-locking folding mechanism the blade is covered
- Convenient: Blade change without tool and integrated belt clip
- Practical: Includes 3 hook blades and 3 trapezoidoid blades



Item no. 02020000

Item no.	Version	Dimensions	Weight	PU
02060002	Professional cutter premium with automatic feeding system	160 mm	120 g	1
02020000	Comfort knife, foldable	120 mm	135 g	1

Aluminium Safety Handle, Fixed Blade, without Blades

Application & Benefits

Robust cutter: Fixed blade perfectly locked!

- Lightweight and robust: Easy-grip aluminum handle
- Simple: Fixed blade
- Convenient: Blade storage compartment in the handle



Item no. 02052000

Freund-Knife Handy Handle and Quiver

Application & Benefits

Powerful cutter: Very good power transfer due to the special shape of the handle!

- Light and stable: Robust snap open aluminum housing
- Enduring: Quiver for 20 blades integrated in the knife body
- Fixed: Blade additionally fixed by a metal pin in the knife body. Only suitable for our Solingen blades



Item no. 02100000

Multitool Made of Stainless Steel with Black Coating

Application & Benefits

Practical assistant: 10 applications and screwdriver bits!

- Versatile: One pair of pliers with 9 other applications, 11 bits and bit holder
- Functional: Pliers with pointed pliers mouth and wire cutter, large knife, small knife, wood saw, slotted screwdriver, bit holder, file with 2 bevels (single cut and cross cut), bottle opener, can opener
- Protected and comfortable: Wellpacked and quickly at hand



Item no. 02401000

Item no.	Version	Dimensions	Weight	PU
02052000	Alu-Safetyhandle, fixed blade, without blades	130 mm	65 g	1
02100000	Freund-Knife, handy handle with quiver	70 mm	195 g	1
02401000	Multitool made of stainless steel with black coating	135 x 70 x 20 mm	333 g	1

Trapezoid Blades "Made in Solingen" 100 Blades

Application & Benefits

- 0,65 mm thick
- " Made in Solingen"
- Ice hardened
- Extra strong quality
- Dispenser à 10 pieces in outer carton of 100 blades



Item no. 02300100

Trapezoid Blades 20 Blades

Application & Benefits

- Two dispensers with each 10 trapezoidal blades on SB card
- Available in 2 qualities



Item no. 02300130

Item no.	Version	Dimensions	Weight	PU
02300100	Trapezoid blades "Made in Solingen", 100 blades	70 mm	420 g	100
02300130	Trapezoid blades "Made in Solingen", 20 blades	70 mm	80 g	20

Hooked Blades "Made in Solingen" 100 Blades

Application & Benefits

- 0,65 mm thick
- "Made in Solingen"
- Ice hardened
- Extra strong quality
- Dispenser à 10 pieces in outer carton of 100 blades



Item no. 02310100

Hooked Blades 20 Blades

Application & Benefits

- Two dispensers with each 10 trapezoidal blades on SB card
- Available in 2 qualities



Item no. 02310130

Item no.	Version	Dimensions	Weight	PU
02310100	Hooked blades "Made in Solingen", 100 blades	70 mm	420 g	100
02310130	Hooked blades "Made in Solingen", 20 blades	70 mm	80 g	20

**Break-Off
Blades
10 Pieces**

Application & Benefits

- 10 blade strips à 8 segments
- Extra sharp
- Packed in a quiver

**Hooked Break-Off
Blades
5 Pieces**

Application & Benefits

- 5 blade strips à 4 segments
- Extra sharp
- Packed in a quiver



Item no. 02340100



Item no. 02340200

Item no.	Version	Dimensions	Weight	PU
02340100	Break-off blades, 10 pieces	115 mm	75 g	10
02340200	Hooked break-off blades, 5 pieces	115 mm	70 g	5

Cardboard Tracing Knife with Fixed Hooked Blade

Application & Benefits

Strong perfectionist:
For cutting of a wide variety of materials!

- Perfect: Solingen ground edge
- Stable: Extremely resilient blade tip in hooked shape
- Power-saving: Low effort



Item no. 02000000

Cardboard Tracing Knife with Fixed Blade

Application & Benefits

Strong ally: For cutting of a wide variety of materials!

- Stable: Extremely resilient blade tip, tapered
- Durable: Riveted blade and wooden handle
- Ergonomic: Ideal shaping of the natural wood handle



Item no. 02011000

Cardboard Tracing Knife with Foldable Blade

Application & Benefits

Foldable ally: For cutting a wide variety of materials!

- Stable: Extremely resilient blade tip, tapered
- Safe: Blade protected in wooden handle
- Ergonomic: Ideal shaping of the of the wooden handle



Item no. 02510000

Item no.	Version	Dimensions	Weight	PU
02000000	Cardboard tracing knife with fixed hooked blade	90 mm	75 g	1
02011000	Cardboard tracing knife with fixed blade	80 mm	80 g	1
02510000	Cardboard tracing knife with foldable blade	75 mm	85 g	1

Insulation Knife with Wooden Handle

Application & Benefits

Insulating Cutter: Universal Insulating knife with 2 teeth!

- Hard: HRC 53 ground on both sides
- Durable: Blade made of stainless steel
- Optimal: For precise cutting of mineral wool insulation materials in sheets or rolls
- Special: Sharp special grinding



Item no. 02055000

Insulation Knife with Long Blade

Application & Benefits

Long Cutter: Extra long insulation knife with special grinding!

- Long: 360 mm blade length
- Hard: HRC 53 ground on both sides
- Durable: Blade made of stainless steel
- Optimal: For precise cutting of mineral wool insulation materials in sheets or rolls
- Special: Sharp special grinding



Item no. 02059000

Item no.	Version	Dimensions	Weight	PU
02055000	Insulation knife with wooden handle	280 mm	145 g	1
02059000	Insulation knife with long blade	360 mm	173 g	1

Hacksaw with Wood Saw Blade

Application & Benefits

**Robust wood divider:
Practical saw for wood!**

- Effective: Precision-set and hardpoint-hardened teeth
- Tensioning: Optimal blade tension adjustable with tension lever
- Durable: Robust oval tube with impact-resistant powder coating
- Safe: Knuckle protection



Item no. 00760530

Hacksaw with Metal Saw Blade

Application & Benefits

Sharp metal cutter: Robust saw for metal!

- Fast: High quality metal saw blade with a length of 60 cm
- Tensioning: Ideal blade tension adjustable with clamping lever
- Durable: Robust oval tube with impact-resistant powder coating



Item no. 00740600

Hacksaw for Pipes and Gutters

Application & Benefits

Handy separator: Small hacksaw for wood and metal that is only 30 cm long!

- Handy: Only 30 cm long
- Dual: Saw has a wood saw blade and a metal saw blade
- Tensioning: Ideal blade tension adjustable with clamping lever
- Durable: Robust oval tube with impact-resistant powder coating
- Safe: Knuckle protection



Item no. 00760300

Item no.	Version	Dimensions	Weight	PU
00760530	Hacksaw with wood saw blade, hard point, 4 tpi	530 mm	650 g	1
00761530	Wood saw blade, 4 tpi	530 mm	50 g	12
00740600	Hacksaw with metal saw blade, 24 tpi	600 mm	600 g	1
00741600	Metal saw blade, 24 tpi	600 mm	50 g	1
00760300	Hacksaw for pipes and gutters, feinzahn, 4 tpi	300 mm	450 g	1
00790000	Metal saw blade double sided, 24 tpi	300 mm	200 g	10
00791000	Metal saw blade one-sided, 24 tpi	300 mm	200 g	10

tpi = teeth per inch

Metal Saw Bow with Pistol Grip

Application & Benefits

- Robust: Heavy bow made of square tube with the dimensions 18 x 10 x 1.35 mm
- Corrosion protected: Green powder coating
- Lightweight: 2K aluminum soft grip
- Traditional: Cross-slot socket



Item no. 00832000

Metal Saw Bow with 2K-Grip

Application & Benefits

- Robust: Heavy bow made of flat steel with the dimensions 18 x 8 mm
- Corrosion protected: Green powder coating
- Comfortable: 2K soft grip
- Traditional: Cross-slotted head
- Patented: Precisen blade tension adjustment



Item no. 00782000

Item no.	Version	Dimensions	Weight	PU
00832000	Metal saw bow with pistol grip, 24 tpi	300 mm	465 g	1
00790000	Metal saw blade double-sided, 24 tpi	300 mm	200 g	10
00791000	Metal saw blade one-sided, 24 tpi	300 mm	200 g	10
00782000	Metal saw bow with 2K-grip, 24 tpi	300 mm	815 g	1
00790000	Metal saw blade double-sided, 24 tpi	300 mm	200 g	10
00791000	Metal saw blade one-sided, 24 tpi	300 mm	200 g	10

tpi = teeth per inch

Premium Multi Purpose Saw with Cork Grip

Application & Benefits

Premium divider: With non-stick you can get easier through the wood!

- Sharp: Wood saw with 3D serration for particularly easy sawing
- Gliding: Non-stick coating for less resistance and easy gliding
- Strong: 1.03 mm extra strong blade for straight cuts and more stability
- Non-stick: Very abrasion resistant coating very abrasion resistant
- Long-lasting: Hardpoint-hardened teeth for long lasting sharpness



Item no. 00861000

Multi Purpose Saw 3D-Teeth

Application & Benefits

Stable separator: The reinforced blade ensures stability and precision!

- Sharp: Wood saw with 3D serration for extra easy sawing
- Strong: 1.03 mm extra strong blade for straight cuts and more stability, protective varnish
- Long-lasting: Hardpoint-hardened teeth for long-lasting sharpness
- Safe: Supplied with tooth guard
- Ergonomic: 2K soft grip with index finger guide



Item no. 00863000

Multi Purpose Saw with Soft Handle

Application & Benefits

Classic divider: Lightweight and short saw with comfortable handle!

- Sharp: Wood saw with cross-ground teeth
- Light: 0.83 mm extra strong blade
- Durable: Hardpoint hardened teeth for longer sharpness
- Safe: Supplied with tooth guard
- Ergonomic: 2K soft grip with index finger guide



Item no. 00811000

Item no.	Version	Dimensions	Weight	PU
00861000	Premium-multi purpose saw with cork grip, 7 tpi	500 mm	450 g	1
00863000	Multi purpose saw, 3D-teeth, 7 tpi	500 mm	450 g	1
00864000	Multi purpose saw with soft handle, 7 tpi	400 mm	330 g	1

tpi = teeth per inch

Jig Saw with 2K Soft Handle

Application & Benefits

Precise separator:
With 300 mm long jig saw blade!

- Sharp: Jig saw with cross-ground teeth
- Corrosion protected: Transparent paint finish
- Durable: Hardpoint-hardened teeth for long-lasting sharpness
- Safe: Supplied with tooth guard
- Ergonomic: 2K soft grip with index finger guide



Item no. 00865000

Jig Saw with Triangle Tip and Belt Pouch

Application & Benefits

Universal separator:
With double-sided saw blade in 2 lengths!

- Universal: For wood, plaster and aerated concrete
- Sharp: 3-dimensional serration
- Practical: 3-point serration for holes in plasterboard
- Unique: Two-sided saw blade for sawing in 2 directions and for a double lifetime
- Safe and portable: Thanks to practical belt pouch
- Ergonomic: 2K soft grip



Item no. 00730150

Jig Saw with Wooden Handle

Application & Benefits

Classic divider:
For plasterboard!

- Sharp: Hardened teeth
- Handy: Untreated beech wood handle
- Safe: Supplied with cutting protection rail



Item no. 95150000

Item no.	Version	Dimensions	Weight	PU
00865000	Jig saw with 2K-softhandle, 7 tpi	300 mm	150 g	1
00730150	Jig saw with triangle tip and belt pouch, 9 tpi	150 mm	100 g	1
00730250	Jig saw with triangle tip and belt pouch, 9 tpi	250 mm	150 g	1
95150000	Jig saw with wooden handle, 7 tpi	160 mm	50 g	1

tpi = teeth per inch

Insulation Material Saw

Application & Benefits

**Insulating separator:
Recesses for less sawing
resistance!**

- Sharp: Special toothing for foam and insulating materials
- Thin: 0.71 mm thick
- Perforated: Special blade for less resistance during sawing and for removal of the sawing material
- Corrosion protected: Transparent lacquer finish
- Safe: Supplied with Tooth guard
- Ergonomic: 2K soft grip with index finger guide

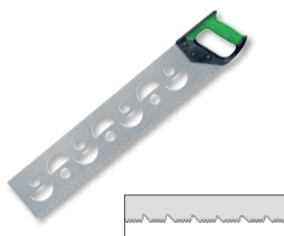

Item no. 00841000

Plaster-Board Saw with Interval Toothing

Application & Benefits

**Plaster cutter: Strong
blade and special teeth for
plaster!**

- Sharp: Special tooth geometry for plasterboard
- Strong: Reinforced saw blade with 1.03 mm blade thickness
- Corrosion protected: Transparent lacquering
- Durable: Hardpoint hardened teeth
- Safe: Supplied with tooth guard
- Ergonomic: 2K soft grip with index finger guide



Item no. 00837000

Roofing Saw 2K Grip

Application & Benefits

**Japanese divider:
Thin pull saw blade and
safety handle!**

- Japanese: The saw blade is "Made in Japan"
- Thin and fast: The pulling allows for a very thin blade and a consequently narrow kerf. The amount of force required is therefore reduced
- Clean: The cutting edge is smooth
- Flush: Flexible blade allows flush cuts



Item no. 00811000

Item no.	Version	Dimensions	Weight	PU
00841000	Insulation material saw, perforated saw blade, Perforated saw blade	500 mm	400 g	1
00837000	Plasterboard saw with interval toothing, 7 tpi	400 mm	390 g	1
00811000	Roofing saw, 2K grip, 0,65 mm, 9 tpi	270 mm	350 g	1

tpi = teeth per inch

Frame Saw Japanese Pull Saw Blade

Application & Benefits

Classic divider: The saw for the carpenter - 60 cm long!

- Thin and fast: The pulling method allows for a very thin blade and consequently a narrow kerf. The force required is therefore reduced
- Clean: The cutting edge is smooth
- Durable: Clamping element made of solid round steel
- Clean: Bar support made of horn-beam for run-free, clean cuts length-wise and crosswise to the course of the wood



Item no. 00838000

Folding Saw Japanese Pull Saw Blade

Application & Benefits

Foldable divider: Easy an safely stow away!

- Japanese: The saw blade is "Made in Japan"
- Thin and fast: The pulling method of operation allows a very thin blade and consequently a narrow kerf. The amount of force required is therefore reduced
- Clean: The cutting edge is smooth
- Flush: Flexible blade allows flush cuts



Item no. 00826000

Item no.	Version	Dimensions	Weight	PU
00838000	Frame saw with japanese pull saw blade, 14 tpi	600 mm	1.1 kg	1
Spare part:				
00838001	Spare blade for japanese frame saw 00838000, 14 tpi	600 mm	400 g	1
00826000	Folding saw with japanese pull saw blade, 9 tpi	195 mm	300 g	1
Spare part:				
00826001	Replacement blade for japanese folding saw 00826000, 9 tpi	195 mm	120 g	1

tpi = teeth per inch

Japanese Pull Saw with Plastic Handle

Application & Benefits

Universal divider: Efficient saw with pistol handle!

- Japanese: The saw blade is "Made in Japan"
- Thin and fast: The pulling method of operation allows a very thin blade and a consequently narrow kerf. The amount of force required is therefore reduced
- Clean: The cutting edge is smooth
- Flush: Flexible blade allows flush cuts
- Universal: For cuts in softwood, PVC, ABS and plywood



Item no. 00821000

Japanese Pull Saw with Rattan Handle

Application & Benefits

Fine cutter: Japanese saw with especially fine toothing!

- Japanese: The saw blade is "Made in Japan"
- Thin and fast: The pulling method of operation allows a very thin blade and a consequently narrow kerf. The amount of force required is therefore reduced
- Clean: The cutting edge is smooth
- Flush: Flexible blade allows flush cuts
- Universal: For cuts in softwood, PVC, ABS and plywood



Item no. 00823000

Item no.	Version	Dimensions	Weight	PU
00821000	Japanese pull saw with plastic handle, 14 tpi	300 mm	300 g	1
Spare part:				
00821001	Spare blade for japanese pull saw 00821000, 14 tpi	300 mm	120 g	1
00823000	Japanese pull saw with rattan handle, 16 tpi	265 mm	200 g	1
Spare part:				
00823001	Spare blade for japanese pull saw 00823000, 16 tpi	265 mm	100 g	1

tpi = teeth per inch

Tongue Shaped Trowel with Wooden Handle

Application & Benefits

- Comfortable: Classic lacquered wooden handle with metal ferrule
- Durable: Blade made of carbon steel, hardened and heat-treated
- Flexible: Conical grinding



Item no. 00411160

Ridge Trowel Round with Wooden Handle

Application & Benefits

- Round: Round cut shoulders
- Comfortable: Classic lacquered wooden handle with metal ferrule
- Durable: Blade made of carbon steel, hardened and heat-treated
- Flexible: Conical cut



Item no. 00460191

Item no.	Version	Dimensions	Weight	PU
00411140	Tongue shaped trowel with wooden handle	140 mm	135 g	1
00411160	Tongue shaped trowel with wooden handle	160 mm	160 g	1
00460191	Ridge trowel with wooden handle, round	190 mm	200 g	1

Tongue Shaped Trowel with Wooden Handle

Application & Benefits

- Comfortable: Classic lacquered natural wood handle
- Durable: Blade made of carbon steel, hardened and heat-treated
- Flexible: Conical grind



Item no. 00470161

Danish Roof Trowel with Wooden Handle

Application & Benefits

- Comfortable: Ergonomic natural wood handle with finger guard
- Durable: Blade made of carbon steel, hardened and heat-treated
- Flexible: Conical grind



Item no. 00480200

Hannover Roof Trowel with Wooden Handle

Application & Benefits

- Comfortable: Classic lacquered natural wood handle
- Durable: Blade made of carbon steel, hardened and heat-treated
- Flexible: Conical grind



Item no. 00430000

Item no.	Version	Dimensions	Weight	PU
00470161	Tongue shaped trowel with wooden handle	160 mm	160 g	1
00480200	Danish roof trowel with wooden handle	200 mm	150 g	1
00430000	Hannover roof trowel with wooden handle	230 x 30 mm	150 g	1

Berlin Roof Trowel with Wooden Handle

Application & Benefits

- Comfortable: Classic lacquered natural wood handle
- Durable: Blade made of carbon steel, hardened and heat-treated
- Flexible: Conical grind
- Pointed: Tapered shape at the front



Item no. 00470001

Masonry Trowel with Wooden Handle and Finger Protection

Application & Benefits

- Bent: Gooseneck angel
- Comfortable: Ergonomic natural wood handle
- Durable: Blade made of carbon steel, hardened and heat-treated
- Flexible: Conical ground



Item no. 00550160

Item no.	Version	Dimensions	Weight	PU
00470001	Berlin roof trowel with wooden handle	165 x 75 mm	250 g	1
00550160	Masonry trowel with wooden handle	160 mm	250 g	1

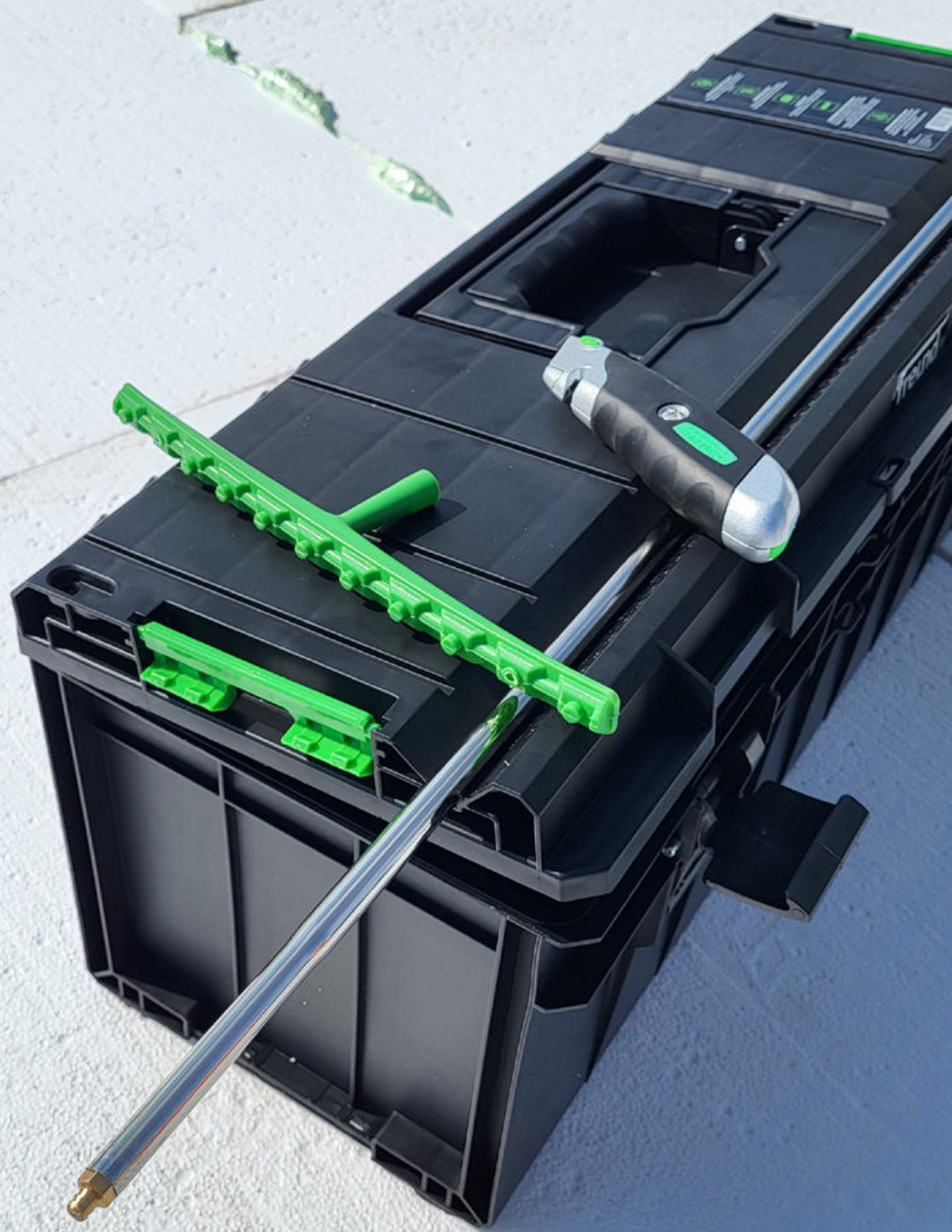

Simple -
**Does it
Twice**





Metal Foam Gun Foam Master XXL

New

Only one click away.
Integrated click function
from the item image to
our webshop.



Application

Extra long foam spreader: Applies foam sheets effortlessly. Even two foam sheets at the same time, thanks to the Fix2Foam doubling attachment supplied!

Benefits & Comfort

- Dual: Doubling attachment enables simultaneous application of two foam lines in one work step
- Ergonomic: Extra long gun tube (80 cm) to be able to work upright
- Angled: Optimal emptying due to curved PTFE adapter so that the cartridge is in a vertical position when working upright
- Comfortable: Rubberised handle for an optimal handling
- Practical: Large brass screw. Easy to grip effortlessly even with gloves



Item no. 01791000

Item no.	Version	Dimensions	Weight	PU
01791000	Metal foam gun Foam Master XXL incl. two doubling attachment Fix2Foam	940 mm	680 g	1
Spare part:				
01791001	Doubling attachment Fix2Foam, 5er Set	270 x 65 mm	5 x 16 g	1



Because it can also go upright

With the XXL metal foam gun you are perfectly equipped for your next project. No more annoying stooping and unnecessary back strain. The 80 cm long gun tube makes foaming ultra-easy while standing. And even better, by using the enclosed doubling attachment, you can apply two foam sheets in one work step.

Metall Foam Gun Plus

Application & Benefits

**Short foam dispenser:
High quality foam gun
with non-stick coating!**

- Quality: Cleaner foam flow
- Non-stick: Non-tick coating inside and outside
- Ergonomic: Comfortable shaped soft grip



Item no. 01780000

Metall Foam Gun Plus XL

Application & Benefits

**Long foam dispenser:
Upright work without
bending down!**

- Ergonomic: Comfortable shaped soft grip and long foam tube, to be able to work upright
- Quality: Clean foam flow
- Non adhesive: Non-stick coating inside and outside



Item no. 01790000

Item no.	Version	Dimensions	Weight	PU
01780000	Metall foam gun plus	340 mm	300 g	1
01790000	Metall foam gun plus XL	600 mm	445 g	1

Chaulking Gun Skeleton Shape

Application & Benefits

Handy Squeezer: The Original from England!

- Open: Skeleton shape
- Original: Made by COX in England
- Durable: High quality workmanship
- Precise: Well adjustable material feed



Item no. 01772000

Chaulking Gun Extremely Robust

Application & Benefits

Strong squeezer: Made for particularly tough adhesives and materials!

- Powerful: Gear ratio 17:1
- Comfortable: Smooth and steady due to two bearings
- Durable: Specially hardened Push block
- Suspendable: Push rod with ladder hook
- Comfortable: Rotating tray



Item no. 01770000

Chaulking Gun Closed Model

Application & Benefits

Universal squeezer: Fits for cartridges and bags!

- Durable: Locking rings are made of metal
- Closed: For cartridges and bags
- Lightweight: Made of aluminum
- Variable: Available in 310 ml and 600 ml version



Item no. 01773000

Item no.	Version	Dimensions	Weight	PU
01772000	Chaulking gun, skeleton shape, 320 ml	330 mm	500 g	1
01770000	Chaulking gun, extremely robust, 320 ml	350 mm	670 g	1
01773000	Chaulking gun, closed model, 310 ml	350 mm	710 g	1
01776000	Chaulking gun, closed model, 600 ml	460 mm	910 g	1
Spare part:				
01773001	Replacement tip for 01773000 + 01776000	55 x 125 mm	8 g	1

Batten Gauge Aluminium Version

Application & Benefits

Lightweight batten distributor: Completely made of aluminum!

- Lightweight: Made of aluminum
- Durable: Measuring scale as metal engraving up to 40 cm
- Comfortable: Adjustable with a star screw



Item no. 00380000

Batten Gauge U-Profile Rod

Application & Benefits

Stable batten allocator: Made from tool steel!

- High quality: Made of sturdy U-profile bar made of tool steel
- Protected: Internal measuring scale up to 40 cm
- Safe: Drop protection



Item no. 00382000

Batten Gauge U-Profile Rod

Application & Benefits

Extra long batten allocator: Measuring length up to 55 cm!

- High quality: Made of sturdy U-profile bar made of tool steel
- Protected: Internal measuring scale up to 55 cm
- Safe: Drop protection



Item no. 00383000

Item no.	Version	Dimensions	Weight	PU
00380000	Batten gauge, aluminium version	400 mm	250 g	1
00382000	Batten gauge, u-profile rod	400 mm	300 g	1
00383000	Batten gauge, u-profile rod	550 mm	400 g	1

Carpenter's Square

Application & Benefits

Perfect angle: For the production and preparation of wooden joints!

- Ideal: Angle of measurement optimized for the carpenter
- Practical: Measuring scale in mm
- Marking: Also suitable for scribing and dimensioning
- Selectable: Available in stainless steel or powder coated



Item no. 01883800

Scribing Tool Alpha

Application & Benefits

Precise Scribing Tool: For the joinery in the carpentry shop!

- Universal: Can be used for all types of joinery both for the scribing of ribs, rafters and straight stairs, as well as for marking single and double offsets
- Corrosion protected: Optional bright yellow powder coating or stainless steel
- Ideal: For easy marking provided with marking holes



Item no. 01882810

Protractor Powder Coated

Application & Benefits

Variable angle: For accurate measurement of angles!

- Long: Leg length 200 mm and diameter 150 mm
- Practical: Lockable double scale
- High quality: Yellow powder coating
- Additional: Can also be used as centering angle and a grinding gauge for spiral drills



Item no. 01880200

Item no.	Version	Dimensions	Weight	PU
01883800	Carpenter's square, powder coated	800 x 320 mm	420 g	1
01883801	Carpenter's square, stainless steel	800 x 320 mm	420 g	1
01882810	Scribing tool alpha, powder coated	810 mm	1.2 kg	1
01882811	Scribing tool alpha, stainless steel	810 mm	1.3 kg	1
01880200	Protractor, powder coated	200 mm	365 g	1

Wooden Bevel with Brass Fitting

Application & Benefits

Useful duplicator: To take off, scribing and transferring angles!

- Practical: Long hole in the stainless steel tongue enables internal measurements
- High quality: Made of walnut wood with brass fittings and stainless steel tongue
- Ergonomic: Milled grooves on the upper and lower side of the handle for comfortable handling



Item no. 01841300

Locksmith Square

Application & Benefits

Durable angle: Made of high quality tool steel!

- Perfect: Usable for angle tests
- Practical: With stop
- High quality: Made of galvanized special steel



Item no. 01883000

Spirit Level Aluminium

Application & Benefits

Precise friend: Permanently accurate measurement results!

- High quality: Patented installation of the vial with 30 years warranty
- Accurate: Electronic adjustment and final check - Measuring accuracy of 0.5 mm/m
- Clean: Anodized aluminium with clean effect for easy cleaning
- Quality: Strong aluminium profile - spirit level "Made in Germany"



Item no. 01890400

Item no.	Version	Dimensions	Weight	PU
01841300	Wooden bevel with brass fitting	300 mm	80 g	1
01883000	Locksmith square	250 mm	490 g	1
01890400	Spirit level, aluminium	400 mm	250 g	1
01890500	Spirit level, aluminium	500 mm	275 g	1
01890600	Spirit level, aluminium	600 mm	360 g	1
01890800	Spirit level, aluminium	800 mm	460 g	1
01891000	Spirit level, aluminium	1.000 mm	550 g	1
01892000	Spirit level, aluminium	2.000 mm	1 kg	1

Scribing Plate Straight Shape, mm Scale

Application

Variable preparer: For scribing sheets for the marking from 5-100 mm!

Benefits & Comfort

- Accurate to size: For marking sheets from 5 mm to 100 mm incl. standing seam marking
- Fast: Easy marking of specified dimensions
- Durable: Tool made of corrosion-resistant stainless steel
- Sharp: Tips were manufactured in a special process



Item no. 01132000

Item no.	Version	Dimensions	Weight	PU
01132000	Scribing plate, straight shape, mm scale	130 mm	75 g	1

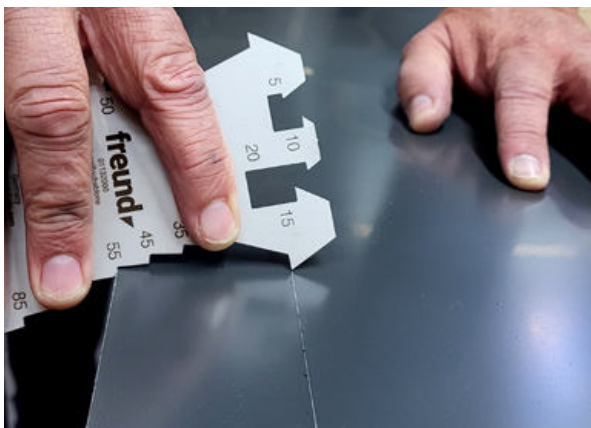

Because simply is super helpful

Working quickly and accurately - that's what it's all about. And with this template, precise dimensions are a child's play, and that in the long run. It fits perfectly in the hand and is suitable for marking sheets from 5 to 100 mm. In addition dimension 28/38 mm for the marking of standing seams.

Scribing Plate Curved Shape mm Scale

Application & Benefits

Curved assistant:
For scribing of sheets for marking!

- Accurate: For marking sheets from 5 mm to 100 mm
- Practical: Curved shape for creating corners for beaded sheets
- Fast: Simple marking of given dimensions



Item no. 01134000

Scribing Plate Straight Shape inch Scale

Application & Benefits

Curved assistant:
For scribing of sheets for marking!

- Accurate: For marking sheets from 1/8 - 4 3/4 inch
- Fast: Simple marking of given dimensions
- Durable: Tool made of corrosion-resistant stainless steel



Item no. 01133000

Item no.	Version	Dimensions	Weight	PU
01134000	Scribing plate, curved shape, mm scale	130 mm	75 g	1
01133000	Scribing plate, straight shape, inch scale	140 mm	65 g	1

Scriber with Carbide Tip

Application & Benefits

Sharp marker:
For scribing of metals and
other materials!

- Durable: With carbide tip
- Easy to grip: Hexagonal ballpoint pen shape
- Fastening: With practical fastening clip



Item no. 01551000

Bow Compass

Application & Benefits

Precise rounder:
For round markings on
metal!

- Standard-compliant: Manufactured according to DIN 6486
- Qualitative: Forged from steel with hardened tips
- Mechanical: Three-piece trade with strong knurled screw



Item no. 05660250

Item no.	Version	Dimensions	Weight	PU
01551000	Scriber with carbide tip	250 mm	35 g	1
05660250	Bow compass	250 mm	270 g	1
05660300	Bow compass	300 mm	405 g	1

Cord Spirit Level

Application & Benefits

**Horizontal measuring Pro:
To hang into the cord!**

- Durable: Made from ABS plastic
- Water and weather resistant: Good waterproofing and resistant to heat and cold
- Suitable for construction sites: Break resistant acrylic tubular bubble
- Practical: V-groove



Item no. 01890001

Freund Wooden Folding Rule

Application & Benefits

- Beech wood
- Green lacquered
- Brass plated steel springs
- Reinforced links
- Duplex spacing



Item no. 01800000

Item no.	Version	Dimensions	Weight	PU
01890001	Cord spirit level	90 mm	15 g	1
01800000	Freund wooden folding rule	2 m	115 g	1

Special Gutter Cord

Application & Benefits

- Shape retaining: With interwoven insert against sagging when wet
- Robust: Extremely tear-resistant and without stretching



Item no. 02961000

Masonry Cord Polypropylene Red

Application & Benefits

- Stable: High tensile strength
- Soft: Smooth, flexible and knot resistant



Item no. 02972050

Masonry Cord Polyethylen Red

Application & Benefits

- Durable: Light stable, rot-resistant
- Clean: Resistant to dirt and moisture
- Fireproof: Flame retardant



Item no. 02981050

Item no.	Version	Dimensions	Weight	PU
02961000	Special gutter cord, orange, 1.5 mm	75 m	110 g	1
02962000	Special gutter cord, green, 1.5 mm	75 m	110 g	1
02972050	Masonry cord, polypropylene, red, 2 mm	50 m	85 g	1
02972100	Masonry cord, polypropylene, red, 2 mm	100 m	165 g	1
02981050	Masonry cord, polyethylen, red, 1.7 mm	50 m	50 g	1
02982050	Masonry cord, polyethylen, red, 2 mm	50 m	75 g	1
02982100	Masonry cord, polyethylen, red, 2 mm	100 m	140 g	1

Chalk Line Freund

Application

Flexible paint marker: Marks dead straight, for all applications!

Benefits & Comfort

- Lightweight and robust: Sturdy die-cast magnesium housing
- Super portable: Practical belt clip. The integrated hook holder also prevents snagging
- Fast: Unwinding without rotating crank - Reel is unlocked with one hand
- Easy: Powder chamber with slider for fast filling
- Flexible: Easy to tighten and allows multiple strokes - thanks to high-quality cord with good chalk absorption
- Practical: Perforated barb for one-man operation



Item no. 03020000

Item no.	Version	Dimensions	Weight	PU
03020000	Chalk line Freund	30 m	160 g	1
Spare part:				
03073000	Replacement cord on reel	30 m	30 g	1



Because color has to come into play

But not just anyhow: Precise marking, all with one hand. Simply execute several strokes without having to rewind each time - it could hardly be easier. And if you need to unwind, you can do it quickly and easily. Thanks to the belt clip, the tool is always directly ready.

Chalk Line Double Version

Application

Precise double pack: Marks dead straight, for all applications!

Benefits & Comfort

- Very light: Sturdy plastic housing saves weight
- Comfortable: Two ergonomic handles with recessed grips
- Time-saving: Two separate chalk chambers, so less refilling is required
- Practical: End of the chalk line each with handle and chalk chamber - therefore no more annoying rolling in
- Easy: Two separate caps for quick filling
- Flexible: Can be super tightened thanks to robust cord with good chalk absorption - makes multiple strokes possible



Item no. 03032000

Item no.	Version	Dimensions	Weight	PU
03032000	Chalk line double version	30 m	250 g	1
Spare part:				
03072000	Replacement cord on reel	30 m	55 g	1

Because twice holds better

And twice means in this case: You work in teams of two with your colleague. You roll in and he rolls out at the same time. The cord is always automatically coated with chalk thanks to two chalk chambers. The constant winding in because of chalk is no longer necessary.

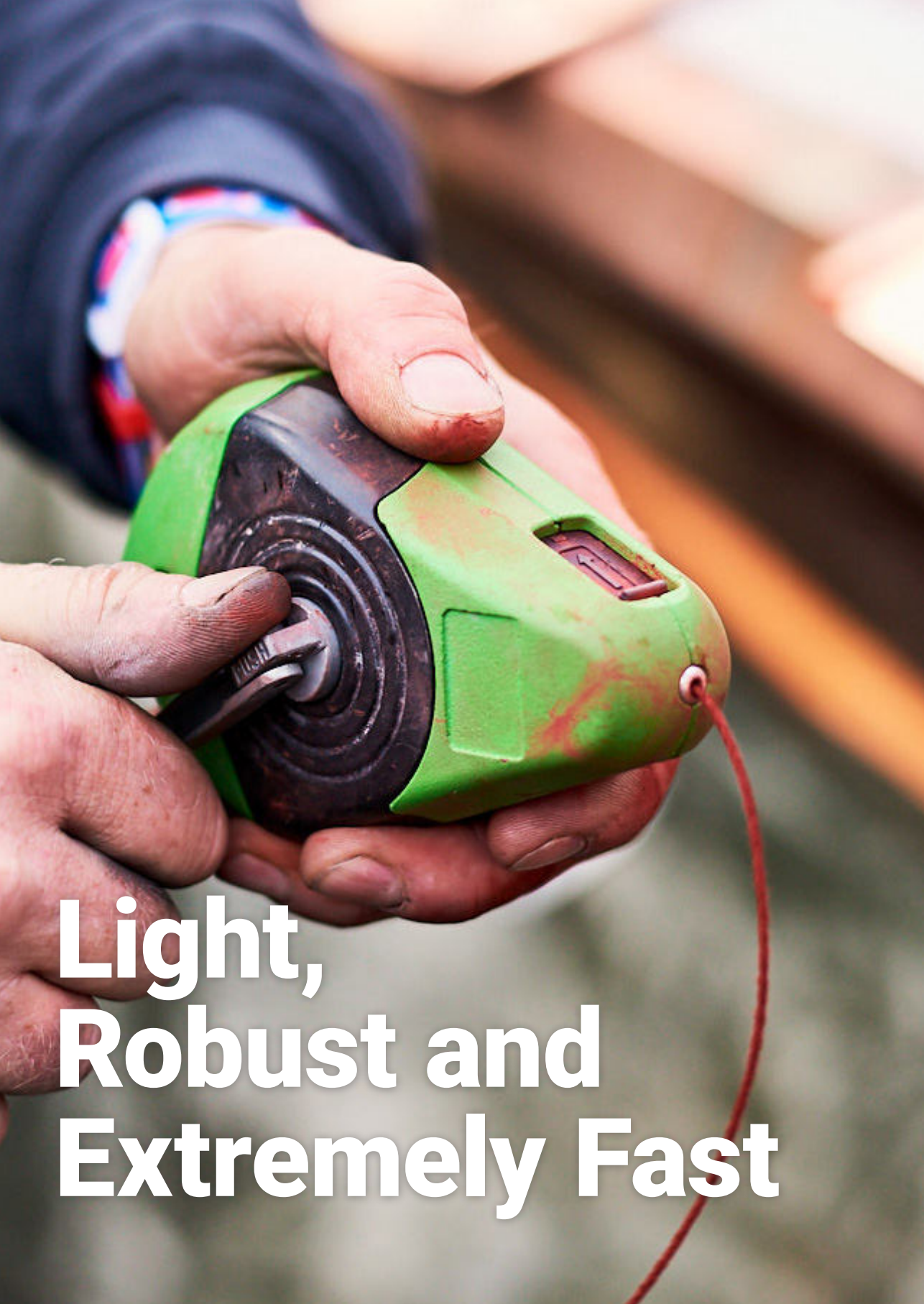

**Light,
Robust and
Extremely Fast**

Chalk Line Turbospeed Plus 5-Times

Application & Benefits

Fast time saver: 5-times transmission ratio saves an enormous amount of time!

- Extremely fast: 5-times fast feed saves a lot of time
- Convenient: The push system prevents the crank from turning during extraction
- Light and robust: The housing is made of magnesium
- Firm and always with you: Stainless steel belt clip



Item no. 03013000

Chalk Line Turbospeed, 3-Times Metal

Application & Benefits

Fast marker: 3-times transmission ratio when winding saves time!

- Robust: Sturdy zinc die-cast housing
- Fast: 3-times speed when winding in
- Durable: High quality cord with good chalk absorption



Item no. 03012000

Chalk Line Turbospeed, 3-Times ABS Plastic

Application & Benefits

Fast and light line: With 3-times transmission ratio!

- Light and strong: ABS plastic housing
- Fast: 3 times speed when winding in
- Durable: High quality cord with good chalk absorption



Item no. 03012001

Item no.	Version	Dimensions	Weight	PU
03013000	Chalk line turbospeed plus, 5-times	30 m	225 g	1
03073000	Replacement cord on reel	30 m	30 g	1
03012000	Chalk line turbospeed, 3-times, metal	30 m	275 g	1
03074000	Replacement cord on reel	30 m	35 g	1
03012001	Chalk line turbospeed, 3-times, ABS plastic	30 m	145 g	1
03074000	Replacement cord on reel	30 m	35 g	1

Chalk Line ERGO

Application & Benefits

- Light: Sturdy plastic housing
- Simple: Handling with Clamp fastener



Item no. 03031000

Chalk Line Straitline, 3,5-Times

Application & Benefits

- Light: Sturdy plastic housing
- Fast: 3,5 x speed



Item no. 03011000

Chalk Line Maxi Stronger Line

Application & Benefits

- Long: 50 m cord
- Strong: The line has a diameter of 2.5 mm and takes a lot of chalk
- Large: The chalk line has a chalk tank for 400 g powder



Item no. 03040000

Item no.	Version	Dimensions	Weight	PU
03031000	Chalk line ERGO	15 m	80 g	1
03011000	Chalk line straitline, 3,5-times	30 m	125 g	1
03011002	Replacement line	30 m	40 g	1
03040000	Chalk line maxi, stronger line	50 m	600 g	1
03040001	Replacement line	50 m	300 g	1

Universal Replacement Line on Card

Application & Benefits

- Cotton line on a card
- Without hook



Item no. 03071000

Universal Replacement Line on Reel

Application & Benefits

- Cotton line on reel
- Without hook



Item no. 03070000

Item no.	Version	Dimensions	Weight	PU
03071000	Universal replacement line on card	30 m	30 g	1
03070000	Universal replacement line on reel	80 m	80 g	1

Chalk Powder for Chalk Line

Application & Benefits

- Practical: Bottle with practical filling spout and lid
- Adhesive: High-quality powder adheres well to the material
- Variable: Available in different colors and bottle sizes available



Color Variants



Item no. 03051000

Chalk Powder for Chalk Line

Application & Benefits

- Practical: Bottle with practical filling spout and lid
- Adhesive: High-quality powder adheres well to the material
- Variable: Available in different colors and bottle sizes available



Color Variants



Item no. 03052500

Item no.	Version	Dimensions	Weight	PU
03050100	Chalk powder, blue	120 mm	100 g	6
03060100	Chalk powder, red	120 mm	100 g	6
03040300	Chalk powder, white	230 mm	300 g	6
03050300	Chalk powder, blue	230 mm	300 g	6
03060300	Chalk powder, red	230 mm	300 g	6
03080300	Chalk powder, black	230 mm	300 g	6
03051000	Chalk powder, blue	280 mm	1 kg	6
03061000	Chalk powder, red	280 mm	1 kg	6
03052500	Chalk powder, blue	200 mm	2.5 kg	1
03062500	Chalk powder, red	200 mm	2.5 kg	1

Professional Marking Set

Application & Benefits

Perfect marker: Colored marking on different surfaces!

- Complete: 2 professional markers and 15 refills
- Colored: Leads in gray, yellow and red
- Everywhere: Almost any material can be marked. Especially suitable for brick, wood, concrete and plastic
- Weatherproof: Marks in rain and sun



Item no. 03080000

Carpenters Pen

Application & Benefits

- Flatoval 12 x 8 mm
- 24 mm long

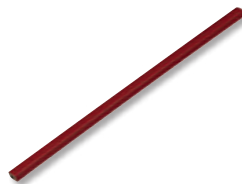

Item no. 03100000

Multigraph Pen

Application & Benefits

Universal marker: For marking on the most different materials!

- Variable: Suitable for smooth surfaces such as metal, sheet metal, foils, plastic or steel
- Stable: Made of lime wood
- Handy: The 3-cornered shape and 24 cm length ensure optimum handling



Item no. 03130000

Item no.	Version	Dimensions	Weight	PU
03080000	Professionell marking set	150 mm	200 g	1
03100000	Carpenters pen	240 mm	15 g	1
03130000	Multigraph pen	240 mm	17 g	1

The World's
Lightest
3 in 1
**Seaming
Machine**

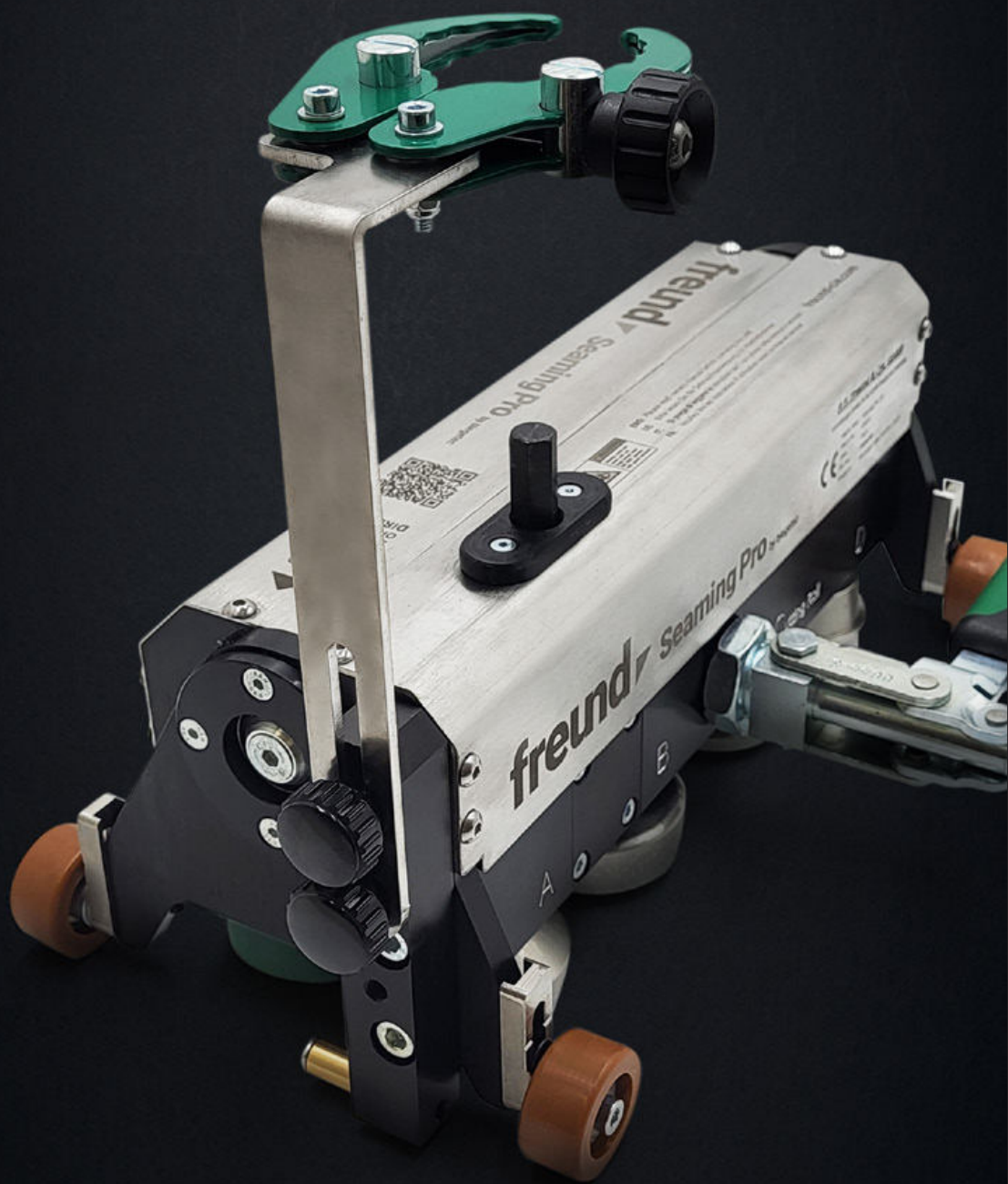

Convenient:
The cordless screwdriver holder has no longer to be specially removed for transport and can be folded to the side without tools

Safe and stabilizing:
The front roller controls the existing profiling and holds the Seaming Pro® in place when closing the fold

Protective:
Due to high-quality rubber wheels, the sheet metal roof is particularly protected during processing

Extra smooth running:
Thanks to the ball bearings in the track wheels, the operation is extra smooth



Ready For The

Outdoor Box



Simple:
The cordless screwdriver can be attached and fixed without tools



Impact resistant, dust and waterproof (IP67):
With the new outdoor case, your Seaming Pro® is especially protected against external effects



Steplessly adjustable in height:
The track wheels are adjustable from 25 mm to 38 mm (1" - 1.5") seamlessly (for this you have to loosen the rubber track wheels with a 4 mm Allen key and adjust the height adjustment to the desired height with a 3 mm Allen key)

Next Generation?

Seaming Machine Seaming Pro®

New Generation

New

Only one click away.
Integrated click function
from the item image to
our webshop.



Application

Universal supporter:
Creates double standing seams
or single standing seams and also
cuts the old seam perfectly – all this
with only one handy device!



Item no. 93000000

Item no.	Version	Dimensions	Weight	PU
93000000	Seaming Machine Seaming Pro® New Generation	300 x 200 x 140 mm	6.5 kg	1

Scope of delivery:

- Seaming Pro® seaming machine equipped with stainless steel forming rolls
- Holder for cordless screwdriver, already mounted and applicable without further tools
- Cutting wheels
- Ball-bearing, height-adjustable rubber roller for seaming heights of 25 mm, 32 mm and 38 mm (1.0" - 1.5")
- Allen key in 3,4,5,6 mm
- Robust transport box is impact resistant and waterproof (IP67)
- User manual

Accessories:

93000010	Track rollers for 25 mm seams (4 pieces)		760 g	1
----------	--	--	-------	---

Your Benefits At A Glance

- Complete: 1 unit for 3 applications – double standing seam, single standing seam and cutting off the old seam
- Fast: Creates double standing seams in just one step – up to 8 to 12 meters (26 - 39ft) per minute
- Wireless: Simply attach your standard cordless screwdriver to one of two holders (roof or facade)
- Light and compact: The device weighs 6.5 kg (14 lbs) without cordless screwdriver
- Problem-solving: Can be unlatched and latched into the seam
- Flexible: Quick modification to the different functions
- Time-saving: No need to pre-seam seam with square seam folder or twin square seam folder
- Steplessly adjustable in height: The track wheels are adjustable from 25 mm to 38 mm (1" - 1.5") seamlessly
- Flat: Fits between facade and scaffolding
- Universal: You can process copper, zinc and aluminum up to 0.7 mm (21 gauge), galvanized or colored steel up to 0.6 mm (22 gauge), as well as stainless steel up to 0.5 mm (24 gauge)
- Extra smooth running: Thanks to the ball bearings in the track wheels, the operation is extra smooth
- Protective: Due to high-quality rubber wheels, the sheet metal roof is particularly protected during processing
- Simple: The cordless screwdriver can be attached and fixed without tools
- Impact resistant, dust and waterproof (IP67): With the new outdoor case, your Seaming Pro® is especially protected against external effects
- Safe and stabilizing: The front roller controls the existing profiling and holds the Seaming Pro® in place when closing the seam



User's Manual



Videos



Because One Device Has Three Functions

More profit, very easy to use and results that are premium – just like you! This is what the Seaming Pro® New Generation – our seaming tool – stands for. With it you save an enormous amount of time. No matter whether you create double standing seams or single standing seams! Or cut off the old seam. It can do everything. Simply mount your regular cordless screwdriver on the Seaming Pro® New Generation and get started!

Get the Seaming Pro® New Generation for your next construction site!



„Awesome 3 in 1 tool.
Super compact and
super easy to use.“

**Jakob Stiegmayr,
Master Tinsmith
from Tirol, Austria**

Brilliant
On
**Sheet
Metal**



Convenient:

You can turn the clamping lever where it does not bother you when working.

Easy to grip:

The Freund bender has a handle that follows your working motion and is always where you need it. You don't have to grab the rods to bend your sheets.



Smooth gliding:

Thanks to the sliding bushings you can adjust the bender precisely and smoothly. At the same time they prevent the locking screw from damaging the hard chrome rods.



Flexible:

With this bender, you are optimally equipped for all sheet thicknesses from 0.3 to 1.2 mm. The distance between the bending rollers is adjustable. Simply loosen the grub screw of the rod with the arrow marking with a 2.5 mm Allen wrench and turn the rod until the desired bending roll spacing is reached. Then fix the screw in place.

You Have It

Tangible quality:

You adjust the bender in no time at all, precisely and smoothly, thanks to the aluminum body sliding bushings! At the same time allow our special hard chrome rods high sheet thicknesses. And the rod material convinces by engine quality: 16 mm thick, super sturdy and very smooth. On top you have an integrated inch scale.

Gentle on material:

There are no more scratches on the sheet metal. Because the beveled inner bending roller allows you bends of 100° and more.

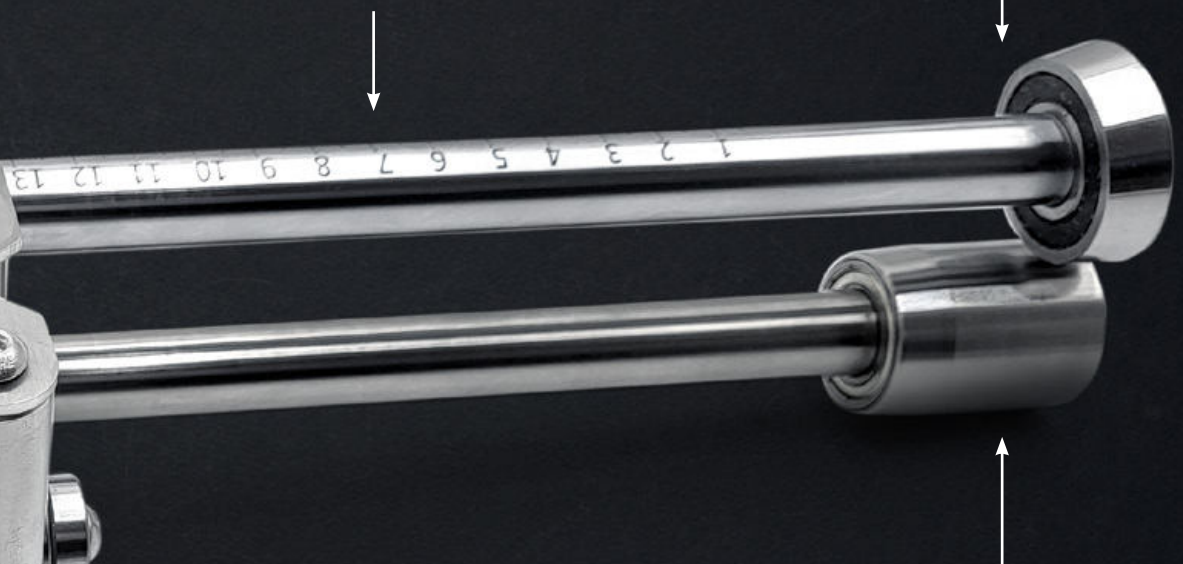

Gentle on material:

To handle the sheet metal more gently, the high bending roller is not only made of one piece, but is also beveled at the top. The material is harder and thicker than individual ball bearings placed on top of each other.

Anti-slip:

You leave no unnecessary scratches. Because on the bottom side of the bender are 2 rubber feet, which prevent the tool from slipping on the roof.

In Your Hand

Premium-Bender with Handle

Application

Comfortable bender: Bender with 4 guide rollers for a comfortable use and upstands from 5 to 200 mm!



Benefits & Comfort

- Quality: Extended lower bending roller with bevel for a better bending result
- Easy to grip: Handle is available for every extension length
- Torsion resistant: 16 mm hard chrome rods for upstands up to 1.2 mm
- Smooth: Sliding bushings and smooth bar material
- Adjustable: Material thickness from 0.3 to 1.2 mm
- Gentle: Rubber feet protect the sheet metal



Item no. 91721000

Item no.	Version	Dimensions	Weight	PU
91720000	Premium-Bender	280 x 152 x 120 mm	2.0 kg	1
91721000	Premium-Bender with handle	280 x 152 x 120 mm	2.1 kg	1



Because bends can also be exact, straight and always look the same

And over the entire length. This is what the new hard chrome benders stand for. Thanks to the engine-quality components, they are super robust and particularly durable. The new hard chrome benders are also really easy to grip. Because the grip is in the right place. Not on the bars, but firmly on the body of the edger. And they don't just look brilliant, they are brilliant on the sheet metal! Thanks to fool-proof depth adjustment and adjustable sheet thicknesses.



Standard-Bender with Handle

Application & Benefits

Handy bender: Small bender for edging upstands from 5 to 200 mm!

- Easy to grip: Handle is available for every extension length
- Torsion resistant: 16 mm hard chrome rods for upstands up to 1.2 mm
- Smooth: Sliding bushings and smooth rod material
- Adjustable: material thickness from 0.3 to 1.2 mm
- Gentle: Rubber feet protect the sheet metal



Item no. 91711000

Max-Bender 350 with Handle

Application & Benefits

Long bender: Bends sheets from 5 to 350 mm!

- Sturdy: 350 mm long hard chrome rods 16 mm Ø for upstands up to 1.2 mm
- Quality: Extended lower bending roller with bevel for a better bending result
- Easy to grip: Handle is available at every extension length
- Smooth: Sliding bushings and smooth rod material
- Adjustable: Material thickness from 0.3 to 1.2 mm
- Gentle: Rubber feet protect the sheet metal



Item no. 91750000

Item no.	Version	Dimensions	Weight	PU
91710000	Standard-Bender	280 x 113 x 120 mm	1.7 kg	1
91711000	Standard-Bender with handle	280 x 113 x 120 mm	1.8 kg	1
91750000	Max-Bender 350 with handle	440 x 152 x 120 mm	2.7 kg	1

Disc-Bender

Application & Benefits

Folding bender:

Bends a sheet from 90° to 180°!

- High: Bends sheets from 5 to 25 mm
- Simple: No adjustments necessary
- Smooth: Three guide rollers support the bend



Item no. 91730000

Double Disc-Bender

Application & Benefits

Double folding bender:

Double width for an even edge!

- Uniform: 6 guide rollers ensure a consistent bend from 90° to 180°
- High: Edging height from 5 to 25 mm
- Simple: No adjustments necessary



Item no. 91731000

Radii-Edger

Application & Benefits

Extremely narrow bender:

Perfect for radii!

- Flexible: For edging from 5 to 25 mm
- Powerful: Long handle for good power transmission
- Gentle: Angled upper bending roller for 100° bends and to avoid scratches



Item no. 91740000

Item no.	Version	Dimensions	Weight	PU
91730000	Disc-Bender	150 x 105 x 115 mm	1.0 kg	1
91731000	Double Disc-Bender	150 x 215 x 115 mm	2.1 kg	1
91740000	Radii-Edger	210 x 65 x 105 mm	0.8 kg	1

Double Premium-Bender

Application & Benefits

Broad bender: Bender with double width and 6 guide rollers and an edging height of 200 mm!

- Consistent: Clean uniform edging even with long sheets
- Torsion-resistant: 16 mm hard chrome rods for upstands up to 1.2 mm
- Smooth: Sliding bushings and smooth bar material
- Quality: Extended lower bending roller with bevel for a better bending result
- Adjustable: Material thickness from 0.3 to 1.2 mm
- Gentle: Rubber feet protect the sheet metal

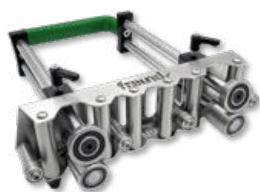

Item no. 91760000

Double Max-Bender 350

Application & Benefits

Broad max bender: Bender with double width and 6 guide rollers and a bending height of 350 mm!

- Consistent: Clean uniform bending even with long sheets
- High: Huge upstand height of 350 mm with high precision
- Torsion-resistant: 16 mm hard chrome rods for upstands up to 1.2 mm
- Smooth: Sliding bushes and smooth bar material
- Quality: Extended lower bending roller with bevel for better bending result
- Adjustable: Material thickness from 0.3 to 1.2 mm
- Gentle: Rubber feet protect the sheet metal

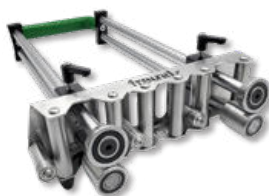

Item no. 91761000

Item no.	Version	Dimensions	Weight	PU
91760000	Double Premium-Bender	355 x 300 x 120 mm	4.0 kg	1
91761000	Double Max-Bender 350	500 x 300 x 120 mm	4.9 kg	1

Full
View
**On
Sheet
Metal**



UltraVision Seaming Pliers 45°, Stack Joint, Window & Scale

Application

Transparent seamer: For a clearer view when bending and edging sheet metal!



Patent



Freund
Choice



Stack Joint

Benefits & Comfort

- Revolutionary: Full view of the sheet metal, thanks to the large bending window in the jaw
- Fast: Millimeter scale allows more precise work without marking
- Strong: No play, no wobbling - with a stack joint
- Ergonomic: New handle shape fits the hand perfectly - so you can get a good grip
- Lightweight: Weight saving thanks to window cut-out and U-channel in the handle
- Gentle on materials: Rounded edges prevent the sheet metal to be damaged during bending



Item no. 01091160

Item no.	Version	Insertion depth	Jaw width	Weight	PU
01091140	UltraVision seaming pliers 45°, window & scale, stack j.	48 mm	40 mm	580 g	1
01091160	 UltraVision seaming pliers 45°, window & scale, stack j.	48 mm	60 mm	630 g	1
01091180	UltraVision seaming pliers 45°, window & scale, stack j.	48 mm	80 mm	700 g	1



Because you have a clear view with it

We have revolutionized the folding pliers. In doing so it does what a folding plier has to do, only better. With the newly designed folding pliers with bending window in the jaw, you can watch the sheet metal bending. And even better - thanks to the laser-engraved millimeter scale, you save time when measuring and marking. The folding plier opens and closes permanently without play. This is ensured by the super strong stack joint of the handles. A feeling of lightness at all levels: Reduced weight thanks to the bending window cut-out in the jaws and U-channel in the ergonomic handle. Everything that makes your job easier.

New

Only one click away.
Integrated click function
from the item image to
our webshop.



UltraVision Seaming Pliers, Straight, Stack Joint, Window & Scale

Application & Benefits

Transparent assistant:
For a clearer view when bending and edging sheet metal!

- Revolutionary: Full view on the sheet metal, thanks to the large bending window in the jaw
- Fast: Millimeter scale allows more precise work without marking
- Ergonomic: New handle shape fits the hand perfectly - so you can get a good grip



Patent

Stack Joint



Item no. 01081160

UltraVision Seaming Pliers 90°, Stack Joint, Window & Scale

Application & Benefits

Transparent bender:
For a clearer view when bending and edging sheet metal!

- Revolutionary: Full view on the sheet metal, thanks to the large bending window in the jaw
- Fast: Millimeter scale allows more precise work without marking
- Ergonomic: New handle shape fits the hand perfectly - so you can get a good grip



Patent

Stack Joint



Item no. 01092260

Item no.	Version	Insertion depth	Jaw width	Weight	PU
01081140	UltraVision seaming pliers, straight, window & scale, stack joint	48 mm	40 mm	530 g	1
01081160	UltraVision seaming pliers, straight, window & scale, stack joint	48 mm	60 mm	680 g	1
01081180	UltraVision seaming pliers, straight, window & scale, stack joint	64 mm	80 mm	880 g	1
01092240	UltraVision seaming pliers 90°, window & scale, stack j.	54 mm	40 mm	580 g	1
01092260	UltraVision seaming pliers 90°, window & scale, stack j.	58 mm	60 mm	730 g	1
01092280	UltraVision seaming pliers 90°, window & scale, stack j.	68 mm	80 mm	780 g	1

Seaming Pliers, Curved 45°, Lap Joint

Application

Quick seamer: For bending and edging sheet metal!



Friend
Choice



Lap Joint

Benefits & Comfort

- Practical: 45° bent
- Gentle on the material: Sheet metal is not damaged by the jaws of the pliers during bending
- Ergonomic: The green, dip-insulated handles lie well in your hand
- Comfortable: The lap joint is very smooth-running
- Durable: High-quality forged tool steel



Item no. 01090040

Item no.	Version	Insertion depth	Jaw width	Weight	PU
01090040	Seaming pliers, curved 45°, lap joint	48 mm	40 mm	600 g	1
01090060	 Seaming pliers, curved 45°, lap joint	48 mm	60 mm	650 g	1
01090080	Seaming pliers, curved 45°, lap joint	48 mm	80 mm	720 g	1



Because everyone has to show an edge

These 45° bent seaming pliers with lap joint are predestined for exact creations of edges. Because of their curved shape you bend and edge sheet metal effortlessly. Particularly convenient: The pliers' jaws close perfectly parallel, and the edges of the pliers head are very straight - but they are not sharp.

Seaming Pliers, Straight, Lap Joint

Application & Benefits

Convenient assistant:
For bending and edging of sheet metal!

- Precise: Accurate bending thanks to cleanly finished jaws
- Precise: The pliers jaws close perfectly parallel
- Ergonomic: The green, insulated handles fit well in your hand



Lap Joint



Item no. 01080040

Seaming Pliers, Curved 90°, Lap Joint

Application & Benefits

Handy seamer: For bending and edging of sheet metal!

- Convenient: 90° bent pliers
- Comfortable: The lap joint is very smooth
- Durable: High quality forged tool steel



Lap Joint



Item no. 01092040

Roll Bag with Seaming Pliers

Application & Benefits

Perfect set: For bending and edging of sheet metal!

- Complete: All three 60s seaming pliers together: Straight - 45° bent - 90° bent
- Packed: High quality roll bag with fastener



Lap Joint



Item no. 04670058

Item no.	Version	Insertion depth	Jaw width	Weight	PU
01080040	Seaming pliers, straight, lap joint	48 mm	40 mm	550 g	1
01080060	Seaming pliers, straight, lap joint	48 mm	60 mm	700 g	1
01080080	Seaming pliers, straight, lap joint	64 mm	80 mm	900 g	1
01092040	Seaming pliers, curved 90°, lap joint	54 mm	40 mm	600 g	1
01092060	Seaming pliers, curved 90°, lap joint	58 mm	60 mm	750 g	1
01092080	Seaming pliers, curved 90°, lap joint	68 mm	80 mm	1.0 kg	1
04670058	Roll bag with seaming pliers			2.3 kg	1

Set includes:

1 X 01080060 Seaming pliers, straight, 1 x 01090060 Seaming pliers, curved 45°, 1 x 01092060 Seaming pliers, curved 90°

Broad Seaming Pliers, Straight, Lap Joint

Application & Benefits

Broad seamer: For bending and edging of sheet metal!

- Perfect: 100 mm wide jaws
- Gentle on material: Sheet metal is not damaged through the jaws of the pliers
- Comfortable: The lap joint is very smooth-running and has a long lifetime



Lap Joint



Item no. 01080101

Broad Seaming Pliers, Straight, Lap Joint

Application & Benefits

Convenient assistant: For bending and edging of sheet metal!

- Precise: Accurate bending thanks to cleanly finished jaws
- Precise: The pliers jaws close perfectly parallel
- Ergonomic: The green, dip-insulated handles lie well in your hand



Lap Joint



Item no. 01080100

Broad Seaming Pliers, Curved 45°, Lap Joint

Application & Benefits

Precise assistant: For bending and edging of sheet metal!

- Perfect: 100 mm wide jaws and 45° bent
- Comfortable: The lap joint is very smooth-running and has a long life time
- Durable: High quality forged tool steel



Lap Joint



Item no. 01090100

Item no.	Version	Insertion depth	Jaw width	Weight	PU
01080101	Broad seaming pliers, straight, lap joint	58 mm	100 mm	870 g	1
01080100	Broad seaming pliers, straight, lap joint	65 mm	100 mm	1.1 kg	1
01090100	Broad seaming pliers, curved 45°, lap joint	68 mm	100 mm	1.1 kg	1

Mini-Seaming Pliers Curved 45°, Lap Joint

Application

Precise assistant: Bends and seams sheet metal!



Lap Joint

Benefits & Comfort

- Convenient: 45° bent pliers
- Filigree: Bends and seams sheet metal where others cannot reach
- Small and handy: Fits perfectly in your pockets of your work clothes
- Precise: Accurate bending thanks to cleanly finished mouth of the pliers
- Ergonomic: The green, dip-insulated handles fit comfortably in your hand
- Precise: The pliers jaws close perfectly parallel



Item no. 01090022

Item no.	Version	Insertion depth	Jaw width	Weight	PU
01090022	Mini-Seaming pliers, curved 45°, lap joint	28 mm	22 mm	220 g	1



Beacaus mini can be big

Do you need detailed sheet metal work for your project? Then the mini seaming pliers 45° bend, lap joint are your ideal assistant. It is not for the rough, but the small handy addition, in order to complete the overall work filigree. Due to its curved shape, it effortlessly bends and seams sheet metal where other never reach.

Mini-Seaming Pliers, Straight, Lap Joint

Application & Benefits

Handy assistant: Bends and seams sheet metal!

- Filigree: Bending and edging sheet metal where others cannot reach
- Small and handy: Fits perfectly in the pockets of your work clothes
- Precise: Accurate bending thanks to the precisely finished jaws of the pliers



Lap Joint



Item no. 01080022

Seaming Pliers, Straight, Stack Joint

Application & Benefits

Straight seamer: For bending and edging of sheet metal!

- Convenient: The stack joint is very smooth-running and has a long service life
- Durable: High quality forged tool steel
- Gentle on material: Sheet metal is not damaged by the jaws of the pliers



Stack Joint



Item no. 01081040

Seaming Pliers, Curved 45°, Stack Joint

Application & Benefits

Ingenious seamer: For bending and edging of sheet metal!

- Practical: 45° bent pliers
- Convenient: The stack joint is very smooth-running and has a long service life
- Durable: High quality forged tool steel



Stack Joint



Item no. 01091060

Item no.	Version	Insertion depth	Jaw width	Weight	PU
01080022	Mini-seaming pliers, straight, lap joint	32 mm	22 mm	200 g	1
01081040	Seaming pliers, straight, stack joint	48 mm	40 mm	550 g	1
01081060	Seaming pliers, straight, stack joint	48 mm	60 mm	700 g	1
01081080	Seaming pliers, straight, stack joint	64 mm	80 mm	900 g	1
01091040	Seaming pliers, curved 45°, stack joint	48 mm	40 mm	600 g	1
01091060	Seaming pliers, curved 45°, stack joint	48 mm	60 mm	750 g	1
01091080	Seaming pliers, curved 45°, stack joint	48 mm	80 mm	925 g	1

Seaming Pliers, Curved 90°, Stack Joint

Application & Benefits

Convenient seamer: For bending and edging of sheet metal!

- Useful: 90° bent pliers
- Convenient: The stack joint is very smooth-running and has a long life time
- Durable: High quality forged tool steel



Stack Joint



Item no. 01092160

Stainless Steel Seaming Pliers, Straight, Lap Joint

Application & Benefits

Straight former: For bending and edging of stainless steel sheets!

- Stainless: For the construction of stainless steel roofs
- Precise: Accurate bending thanks to precisely finished pliers jaws
- Precise: The pliers jaws close perfectly parallel
- Ergonomic: The green, dip-insulated handles fit well in your hand



Lap Joint



Item no. 01080061

Stainless Steel Seaming Pliers 45°, Lap Joint

Application & Benefits

Curved former: For bending and edging of stainless steel sheets!

- Stainless: For the construction of stainless steel roofs
- Practical: 45° bent
- Gentle on material: Sheet metal is not damaged by the jaws of the pliers when bending



Lap Joint



Item no. 01090061

Item no.	Version	Insertion depth	Jaw width	Weight	PU
01092160	Seaming pliers, curved 90°, stack joint	58 mm	60 mm	750 g	1
01080061	Stainless steel seaming pliers, straight, lap joint	47 mm	60 mm	550 g	1
01090061	Stainless steel seaming pliers, curved 45°, lap joint	48 mm	60 mm	605 g	1

Squeezing Folding Pliers, Straight, Stack Joint

Application

Flat former: For bending high seams and squeezed seams!



Benefits & Comfort

- Power-saving: Thanks to the long pliers handles
- Convenient: The stack joint is very smooth-running and has a long service life
- Practical: Particularly high insertion depth of 80 mm
- Gentle on material: Sheet metal is not damaged when bent by the jaws of the pliers
- Handy: The green, dip-insulated handles fit perfectly in the hand
- Accurate: Fine bends thanks to cleanly finished jaws
- Durable: High-quality forged tool steel



Item no. 01100080

Item no.	Version	Insertion depth	Jaw width	Weight	PU
01100080	Squeezing folding pliers, straight, stack joint	80 mm	80 mm	820 g	1

Because squeezed seams need a specialist

With these seaming pliers, you not only perform precise sheet metal work, but are also extremely flexible thanks to the high insertion depth. Higher seams and squeezed seams are no longer an obstacle for you with these pliers. The pliers jaws close perfectly parallel and bend the sheet easily and precisely. For high and safe working comfort.

Squeezing Folding Pliers, Straight, Lap Joint

Application

Flat former: For bending high seams and squeezed seams!



Freund
Choice



Lap Joint

Benefits & Comfort

- Handy: Particularly high insertion depth of 80 mm
- Gentle on the material: Sheet metal is not damaged by the jaws of the pliers during bending
- Easy to handle: The green, dip-insulated handles fit perfectly in the hand
- Comfortable: The joint is very smooth-running and has a long life time
- Accurate: Fine bends thanks to precisely finished mouth of the pliers
- Durable: High-quality forged tool steel



Item no. 01100081

Item no.	Version	Insertion depth	Jaw width	Weight	PU
01100081	 Squeezing folding pliers, straight, lap joint	80 mm	80 mm	820 g	1

Corner Seaming Pliers, Lap Joint

Application & Benefits

Perfect corner seamer: For seams into the smallest corner!

- Square: For seams right into the corner
- Precise: Accurate bends thanks to precisely finished pliers jaws
- Flat: The pliers jaws run parallel over the entire surface
- Precise: Bends with the surface and not with the edge
- Ergonomic: The green insulated handles fit well in your hand



Lap Joint



Item no. 01170060

Round Seaming Pliers, Curved 45°, Lap Joint

Application & Benefits

Smallest seamer: For bending and edging of round seams!

- Handy: 18 mm wide and 45° bent
- Filigree: Bends and folds sheet metal where others cannot reach
- Small and handy: Fits perfectly in the pockets of your work clothes



Lap Joint



Item no. 01094018

Seam Opening Pliers, Lap Joint

Application & Benefits

Smart colleague: For opening of standing seams!

- Clean: Gentle opening of the seams
- Comfortable: The lap joint is very smooth-running
- Handling: The dip-insulated handles fit perfectly in your hand



Item no. 01070250

Item no.	Version	Insertion depth	Jaw width	Weight	PU
01170060	Corner seaming pliers, lap joint	66 mm	60 mm	1.2 kg	1
01094018	Round seaming pliers, curved 45°, lap joint	42 mm	18 mm	500 g	1
01070250	Seam opening pliers, lap joint		30 mm	450 g	1

Flat Nose Pliers, Lap Joint

Application & Benefits

Flat assistant: Indispensable for sheet metal jobs!

- Easy to grip: Pliers jaws with serrations
- Comfortable: Dip-insulated handles
- Precise: The pliers jaws close parallel



Lap Joint



Item no. 01370240

Round Nose Pliers, Lap Joint

Application & Benefits

Round assistant: Indispensable for the fabrication of corners!

- Easy to grip: Pliers jaws with serrations
- Comfortable: Dip-insulated handles
- Precise: The pliers jaws close parallel



Lap Joint



Item no. 01360240

Item no.	Version	Insertion depth	Dimensions	Weight	PU
01370240	Flat nose pliers, lap joint	50 mm	240 mm	440 g	1
01360240	Round nose pliers, lap joint	65 mm	240 mm	420 g	1

Seaming Pliers, Straight, Compound Leverage

Application & Benefits

Extremely wide bender:
Thanks to compound leverage up to 150 mm width!

- Perfect: Particularly large working width
- Smooth running: Integrated compound leverage with self-opening
- Accurate: Precisely finished tong jaws for perfect bending
- Choice: 2 different working widths available: 80 mm and 150 mm



Item no. 01080150

Seaming Pliers, Bent, Compound Leverage

Application & Benefits

Wide bender: Thanks to compound leverage up to 80 mm width!

- Ergonomic: Bent shape and 2K soft grips
- Adhesive: Jaws with V-notches
- Smooth running: Compound leverage and self-opening
- Wide: Working width of 80 mm



Item no. 01093080

Single Handed Edger 108 HK

Application & Benefits

Convenient edger: Bending and seaming of sheets without marking!

- Settable: Adjustable Depth stop from 7 mm to 25 mm
- Angular: Adjustable seaming angle through adjustable stop in the handle
- Reversing: Complete reversal of the folding by impact function of the pliers head



Item no. 91110000

Item no.	Version	Insertion depth	Jaw width	Weight	PU
01083080	Seaming pliers, straight, compound leverage	32 mm	80 mm	600 g	1
01080150	Seaming pliers, straight, compound leverage	32 mm	150 mm	800 g	1
01093080	Seaming pliers, bent, compound leverage	32 mm	80 mm	650 g	1
91110000	Single handed edger, 108 hk		650 mm	800 g	1

Seaming Pliers, Straight, Lap Joint

Application

Versatile finisher: For bending and edging of already installed sheet metal panels!



Freund
Choice



Lap Joint



Benefits & Comfort

- Durable: High quality forged tool steel
- Ergonomic: Long pliers handles simplify work in standing position
- Flexible: Large working width (120 mm - 200 mm) and insertion depth (120 mm - 170 mm)
- Gentle on material: Sheet metal is not damaged by the jaws of the pliers when bending
- Easy: The handle ends are rounded on both sides for easy bending

Item no. 01141160

Item no.	Version	Insertion depth	Jaw width	Weight	PU
01141120	Seaming pliers, straight, lap joint	120 mm	120 mm	1.9 kg	1
01141140	Seaming pliers, straight, lap joint	120 mm	140 mm	2.0 kg	1
01141160	Seaming pliers, straight, lap joint	170 mm	160 mm	2.5 kg	1
01141180	 Seaming pliers, straight, lap joint	170 mm	180 mm	2.6 kg	1
01141200	Seaming pliers, straight, lap joint	170 mm	200 mm	2.7 kg	1

Because everything has to fit in the end

And these lap joint pliers are just right for that. Particularly convenient: The pliers jaws close perfectly parallel, and the edges of the pliers head run very straight - but they are not sharp.

Seaming Pliers, Curved 45°, Lap Joint

Application & Benefits

Curved former: Edging of already installed sheet metal panels!

- Comfortable: 45° bent and therefore particularly ergonomic
- Durable: High-quality forged tool steel
- Selection: Large selection of different models: Working width (120 mm - 200 mm) and insertion depth (80 - 130 mm)



Lap Joint



Item no. 01161120

Seaming Pliers, Skewed

Application & Benefits

Practical corner former: For corners for sheet metal panels that have already been installed!

- Additional: 45° skewed jaws for the processing of corners
- Great: Large working width (180 mm) and insertion depth (175 mm)
- Gentle on material: Sheet metal is not damaged by the jaws when bending



Lap Joint



Stack Joint



Item no. 01140181

Item no.	Version	Insertion depth	Jaw width	Weight	PU
01161120	Seaming pliers, curved 45°, lap joint	80 mm	120 mm	2.9 kg	1
01161140	Seaming pliers, curved 45°, lap joint	80 mm	140 mm	3.0 kg	1
01161160	Seaming pliers, curved 45°, lap joint	130 mm	160 mm	3.1 kg	1
01161180	Seaming pliers, curved 45°, lap joint	130 mm	180 mm	3.2 kg	1
01161200	Seaming pliers, curved 45°, lap joint	130 mm	200 mm	3.3 kg	1
01141181	Seaming pliers, skewed, lap joint	175 mm	180 mm	3.1 kg	1
01140181	Seaming pliers, skewed, stack joint	175 mm	180 mm	3.4 kg	1

Seaming Pliers, Straight, Stack Joint

Application & Benefits

Straight former: For edging of already installed panels!

- Convenient: The stack joint is very smooth-running and has a long life time
- Durable: High quality forged tool steel
- Selection: Large selection of different models: Working width (120 - 200 mm) and insertion depth (130 - 160 mm)



Stack Joint



Item no. 01140120

Seaming Pliers, Curved 45°, Stack Joint

Application & Benefits

Curved finisher: For edging of already installed panels!

- Versatile: 45° bent pliers
- Durable: High quality forged tool steel and stack joint
- Gentle on material: Sheet metal is not damaged by the jaws of the pliers when bending



Stack Joint



Item no. 01160140

Item no.	Version	Insertion depth	Jaw width	Weight	PU
01140120	Seaming pliers, straight, stack joint	130 mm	120 mm	2.9 kg	1
01140140	Seaming pliers, straight, stack joint	130 mm	140 mm	3.0 kg	1
01140160	Seaming pliers, straight, stack joint	160 mm	160 mm	3.0 kg	1
01140180	Seaming pliers, straight, stack joint	160 mm	180 mm	3.2 kg	1
01140200	Seaming pliers, straight, stack joint	160 mm	200 mm	3.3 kg	1
01160140	Seaming pliers, curved 45°, stack joint	90 mm	140 mm	2.0 kg	1
01160160	Seaming pliers, curved 45°, stack joint	120 mm	160 mm	2.9 kg	1
01160180	Seaming pliers, curved 45°, stack joint	120 mm	180 mm	3.0 kg	1
01160200	Seaming pliers, curved 45°, stack joint	120 mm	200 mm	3.2 kg	1

Hand Notcher 35

Application

Smart simplifier: Cuts rounded profile incisions in sheets with a width of 3 millimeters!

Benefits & Comfort

- Time-saving: Rounded cutting end eliminates the need for additional perforation and prevents tearing of the sheet metal
- Flexible: The particularly long notching of 35 mm length can be continued endlessly
- Durable: Locking lever protects the cutting edge
- Convenient: Tool change is not necessary
- Ergonomic: Dip-insulated handles fit perfectly in the hand
- Effort-saving: The long lever handles reduce the effort required, the robust return spring makes your work easier



Item no. 00371000

Item no.	Version	Dimensions	Weight	PU
00371000	Hand Notcher 35 for 35 x 3 mm hand notching cut	300 x 650 mm	530 g	1



Because one step is faster than three

The hand notcher makes the profile cuts and the hole punching in one. So you only need this one tool. For example, for pan corners for the wall connection of the single or double seam. By the way, you can continue the cut endlessly.

Notching And Punching Pliers Compound Leverage

Application & Benefits

Long punch: Creates long holes in different sheets!

- Long: Creates long holes of 3 mm x 15 mm
- Limiting: Adjustable stop from 9 mm to 21 mm
- Strong: Punches aluminum and zinc up to 0.8 mm and plastic up to 1 mm
- Smooth running: Thanks to integrated compound leverage



Item no. 00360020

Punching Pliers Compound Leverage

Application & Benefits

Powerful puncher: Creates round holes in various sheets!

- Exchangeable: With different punches: 3.3 mm, 4.1 mm, 4.9 mm and 6.2 mm
- Limitable: Adjustable depth stop up to 43 mm
- Measurable: Accurate scaling
- Leverage: Compound leverage - generates a force of 740 kg



Item no. 00360010

Hand Notcher with 2K soft handle

Application & Benefits

Triangular punch: Creates accurate V-notches!

- Universal: For sheet thicknesses from 0.48 to 0.71 mm
- Deep: Insertion depth of 254 mm
- Triangular: Cuts clean 30° V-notches
- Comfortable: 2K soft grip for comfortable handling



Item no. 00370025

Item no.	Version	Dimensions				Weight	PU
00360020	Notching and punching pliers, compound leverage				310 mm	825 g	1
00360010	Punching pliers, compound leverage				270 mm	965 g	1
Punch:	Ø 3.3 mm	Ø 4.1 mm	Ø 4.9 mm	Ø 6.2 mm			
Steel Sheets	1.5 mm	1.5 mm	1.2 mm	0.8 mm			
Stainless Steel	1.2 mm	1 mm	0.8 mm	0.5 mm			
Aluminium	3 mm	2 mm	2 mm	1.5 mm			
00370025	Hand notcher with 2K soft handle				215 mm	450 g	1

Seam Locking Pliers with PVC Protection

Application

Flexible clamp: Clamps and fixes profiled sheet metal and smooth sheet metal!



PVC-Jaws

Benefits & Comfort

- Gentle: Protects sheet metal surfaces with flexible and removable PVC coatings
- First-class: Tangible quality, thanks to the high-quality despite many moving parts
- Precise: Fixes panels exactly at the upper edge of the seam - thanks to the defined clamping range of the jaw tips
- Flexible: The knurled grip screw with hexagon socket can be conveniently adjusted - for permanent fixation of the sheets
- Simple: Open and close in a blink of an eye thanks to the grip quick-release fastener
- Universal: The clamping range goes up to 30 mm



Item no. 01332000

Item no.	Version	Dimensions	Weight	PU
01332000	Seam locking pliers with PVC protection, clamping range 30 mm	225 x 70 mm	650 g	1
Spare part:				
01332001	PVC replacement protection, 2-piece		10 g	1



Because firm can also be gentle

The plastic coating of the grip jaws protects the surface. You can fix the sheets effortlessly to the upper edge of the seam - this preserves the stretch area. With its anti-slip coating made of soft PVC, the tool is suitable for any seam. And durable. Thanks to the burned-in powder coating.

Wide Jaw Locking Pliers with PVC Protection

Application & Benefits

Ingenious Gripmaster: Locks and fixes building materials effortlessly!

- Ideal: Ensures a perfect hold on fine and rough surfaces
- Wear-resistant: High-quality tool steel with inductively hardened grip surfaces
- Flexible: The knurled-grip screw with hexagon socket can be smoothly and comfortably adjusted - for permanent fixing of the sheet



Item no. 01331000

Long Nose Locking Pliers

Application & Benefits

Narrow Gripmaster: Locks and fixes building materials effortlessly!

- Narrow: Especially suitable for narrow tapered areas
- Wear resistant: High quality tool steel with inductively hardened grip surfaces
- Flexible: The knurled-grip screw with hexagon socket can be smoothly and comfortably adjusted
- Comfortable: With wire cutter



Item no. 01334000

Universal Sheet Metal Pliers

Application & Benefits

- Comfortable: With dipped insulated handles
- Durable: High-quality forged parts
- Accurate: Precisely ground pliers mouth



Item no. 01071300

Item no.	Version	Dimensions	Weight	PU
01331000	Wide jaw locking pliers with PVC protection, jaw width 80 mm	200 mm	460 g	1
Spare part:				
01331001	PVC replacement protection, 2-piece		8 g	1
01334000	Long nose locking pliers	165 mm	100 g	1
01071300	Universal sheet metal pliers	300 mm	600 g	1

Locking Pliers, Curved Jaws

Application

Ingenious grip master: Locks and fixes various building materials effortlessly!



Benefits & Comfort

- Perfect: Ensures a perfect grip on fine and rough surfaces
- Wear-resistant: High-quality tool steel with inductively hardened grip surfaces
- Flexible: The knurled grip screw with hexagon socket can be adjusted smoothly and conveniently - for permanent fixing of the sheets
- Simple: Open and close in no time at all thanks to the grip quick-release fastener
- Durable: Thanks to the burned-in powder coating
- Quality: Durably smooth-running mechanics makes the workmanship tangible



Item no. 01330175

Item no.	Version	Dimensions	Weight	PU
01330100	Locking pliers, curved jaws, clamping range 0 - 50 mm	145 x 40 mm	150 g	1
01330175	 Locking pliers, curved jaws, clamping range 0 - 55 mm	175 x 55 mm	360 g	1
01330250	Locking pliers, curved jaws, clamping range 0 - 60 mm	225 x 65 mm	550 g	1

Because you don't stop before the job is done

Really tight and really fast at the same time? Exactly like this. You simply open and close the locking pliers. And fix all materials with a clamping width of up to 60 millimeters. Securely and permanently. By the way: Thanks to the powder coating, your pliers will last a long time.

Mini Water Pump Pliers

Application

Convenient assistant: Loosens or fixes workpieces comfortably and universally!

Benefits & Comfort

- Precise: The grooves in the pliers head grip optimally into each other
- Variable: The jaw size can be locked quickly, easily and securely
- Precise: The adjustment mechanism is milled with high precision
- Ergonomic: The handle in wave form



Item no. 01653000

Item no.	Version	Dimensions	Weight	PU
01653000	Mini water pump pliers, clamping range 44 - 68 mm	170 x 44 mm	170 g	1

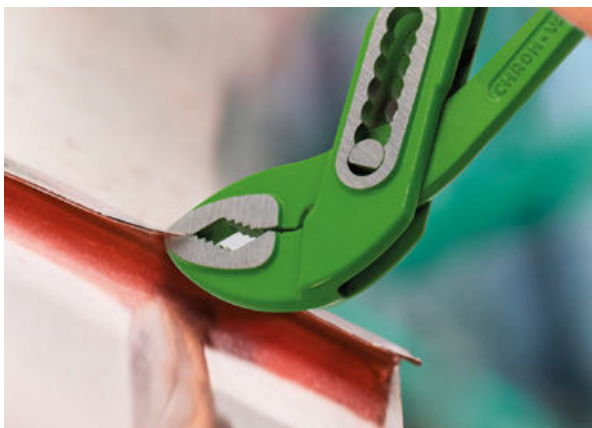

Because small can also grip properly

This compact, stable, durable companion for all occasions has it, the grip. It takes up hardly any space and never gets in the way - neither in the toolbox nor in the work trousers. At the same time the pliers fit perfectly in your hand. And thanks to the mini version, you can get into tight places particularly well.

Water Pump Pliers

Application & Benefits

Practical allround talent:
Holds and grips reliably!

- Precise: The grooves in the pliers head interlock optimally
- Variable: The jaw size can be locked quickly, easily and safely
- Precise: The adjustment mechanism is milled with high precision
- Ergonomic: The handle in wave form



Item no. 01650000

Water Pump Pliers

Application & Benefits

Comfortable allround talent:
Holds and grips reliably!

- Ergonomic: The choice is yours: 2K soft grip or dip-insulated handle
- Precise: The grooves in the head of the pliers interlock optimally
- Variable: The jaw size can be locked quickly, easily and safely
- Precise: The adjustment mechanism is milled with high precision



Item no. 01652000

Rabitz Pliers

Application & Benefits

Universal allrounder: For twisting and cutting tie wire!

- High quality: Forged tool steel
- Hard: Cutting edges induction hardened
- Shiny: Polished head
- Selection: 2 sizes are available



Item no. 01660220

Item no.	Version	Dimensions	Weight	PU
01650000	Water pump pliers	240 mm	290 g	1
01651000	Water pump pliers, dip-insulated	240 mm	300 g	1
01652000	Water pump pliers, 2K handle	240 mm	335 g	1
01660220	Rabitz pliers	225 mm	325 g	1
01660250	Rabitz pliers	250 mm	390 g	1



**With The
Flexible
Grip-Master
Everything
Under Control**

Single Standing
Seam Closing

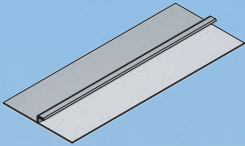

Double Standing
Seam Closing

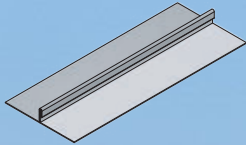

Convenient Multipurpose Creator



Double Standing Seam Closer with PVC Jaws

Application

Convenient multipurpose creator: Closes the squareseam, creates the double standing seam!



PVC-Jaws

Benefits & Comfort

- Flexible: Precisely manufactured PVC jaws make both seaming operations possible with only one tool
- Gentle: PVC jaws protect the surface
- Durable: PVC jaws are long-lasting and replaceable
- Convenient and fast: No tool change necessary for the double standing seam
- Effort-saving: Lever mechanism makes work easier



Item no. 92170000

Item no.	Version	Dimensions	Weight	PU
92170000	Double standing seam closer with PVC jaws, working width 220 mm	490 x 220 mm	2.4 kg	1
Spare part:				
92170001	Replacement jaws	220 mm	200 g	1



Because two is better than one

The complete seaming process is done with just one tool. First close the squareseam, then create the double standing seam. Protecting the surface is really simple. And especially with coated materials. Thanks to the integrated PVC jaws with a working width of 220 mm.

Eave Closer with PVC Jaws

Application

Consistent sealant:
Closes prepared eaves edges!



Benefits & Comfort

- Gentle: PVC jaws protect the surface
- Comfortable: Closes the eave edging easily and quickly
- Ergonomic: Lever handles fit perfectly in your hand
- Durable: PVC jaws are long-lasting and replaceable
- Effort-saving: Lever mechanism makes work easier



Item no. 92080000

Item no.	Version	Dimensions	Weight	PU
92080000	Eave closer with PVC jaws, working width 220 mm	400 x 220 mm	2.2 kg	1
Spare part:				
92080001	Replacement jaws	215 mm	125 g	1



Because a good finish counts

You get that with our eaves closer with PVC jaws! Thanks to the PVC coating, the eave closer protects the surface of the processed material. Especially if they are coated and sensitive. The integrated PVC jaws are also very stable and durable. Quick wear and tear is out of the question here.

Square-Seam Folder First Stage

Application & Benefits

- Closing: Closes the square-seam (flag fold) SPM 30/80
- Practical: Particularly suitable for angled facades
- Measurable: Working width 220 mm
- Selectable: Available in 2 versions: Stainless steel and powder coated

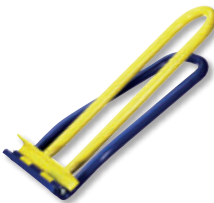

Item no. 91100000

Square-Seam Folder First Stage Upright

Application & Benefits

- Upright: Due to the 3-way height adjustment, the tool can be adjusted individually to any body size
- Closing: Closes the square-seam (flag fold) SPM 30/80
- Measurable: Working width 220 mm



Item no. 91101000

Double Square-seam Folder Second Stage

Application & Benefits

- Double-closing: Creates from the closed single square-seam a double standing seam
- Measurable: Working width 220 mm
- Selection: Available in 2 versions: Stainless steel and powder coated



Item no. 91170000

Item no.	Version	Dimensions	Weight	PU
91100000	Square-seam folder, 111 WFSC, powder coated	220 mm	2 kg	1
91100001	Square-seam folder, stainless steel, 1119 WFSC VA	220 mm	2 kg	1
91101000	Square-seam folder, upright, 128 WFSC ST, powder coated	720 mm	3.5 kg	1
91170000	Double square-seam folder, 117 WDF, powder coated	220 mm	2.5 kg	1
91170001	Double square-seam folder, stainless steel, 1179 WDF VA	220 mm	2.5 kg	1

Double Square-Seam Folder Second Stage Upright

Application & Benefits

- Upright: Due to the 3-way height adjustment, the tool is individually adjustable to any body size
- Double-closing: Creates from the closed single square-seam a double standing seam
- Measurable: Working width 220 mm



Item no. 91171000

Eaves Edger

Application & Benefits

- Edging: For folding the sheet metal at the eaves or dormers, possible over 90° if necessary
- Measurable: Working width 250 mm
- Durable: By applying a high-quality powder coating

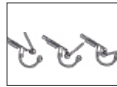

Item no. 91070000

Eaves Closer

Application & Benefits

- Closing: To close the pre-bent seam at the the eaves or dormer
- Working width: 220 mm
- Measurable: Working width 220 mm
- Selection: Available in 2 versions: Stainless steel and powder coated

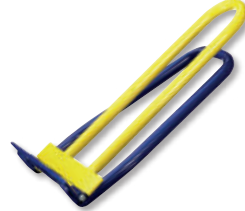

Item no. 91080000

Item no.	Version	Dimensions	Weight	PU
91171000	Double square-seam folder, upright, 131 WDF ST, powder coated	220 mm	3.6 kg	1
91070000	Eaves edger, 105 TK, powder coated	250 mm	1.7 kg	1
91080000	Eaves closer, 106 TSCH, powder coated	220 mm	2.1 kg	1
91080001	Eave closer, stainless steel, 1069 TSCH VA	220 mm	2.1 kg	1

Round Dormer Closer

Application & Benefits

- Closing: Prefabricated round SPM sheet metal profiles can be closed easily even with small radii
- Measurable: Working width 65 mm
- Durable: By applying a high-quality powder coating
- Selection: There is a 320 mm long and a 210 mm long version



Item no. 91180000

Round Profil Closer

Application & Benefits

- All-round: The round profile closer is used to close special round profiles
- Measurable: Working width 220 mm
- Durable: By applying a high-quality powder coating

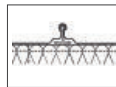

Item no. 91220000

Sheet Bending Jaws 300 mm

Application & Benefits

- Bending: You use the sheet metal bending jaws to bend sheet metal in unlimited length quickly and cleanly directly on the construction site
- Universal: For box and valley gutters, high wall flashings, wall connections
- Measurable: Working width 300 mm



Item no. 91050000

Item no.	Version	Dimensions	Weight	PU
91180000	Round dormer closer, long version, 119 RGS, powder coated	320 mm	1 kg	1
91181000	Round dormer closer, short version, 127 RGS, powder coated	210 mm	900 g	1
91220000	Round profil closer, 140 RPS, powder coated	220 mm	2.6 kg	1
91050000	Sheet bending jaws, 102 BG 300, powder coated	300 mm	5 kg	1

Sheet Bending Jaws 500 mm

Application & Benefits

- Bending: You use the sheet metal bending jaws to bend sheet metal in unlimited length quickly and cleanly directly on the construction site
- Universal: For box and valley gutters, high wall flashings, wall connections
- Measurable: Working width 500 mm

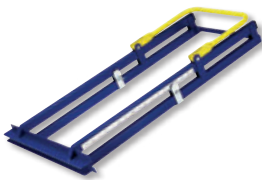
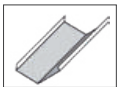

Item no. 91040000

Sheet Bending Jaws 1000 mm

Application & Benefits

- Bending: You use the sheet metal bending jaws to bend sheet metal in unlimited length quickly and cleanly directly on the construction site
- Universal: For box and valley gutters, high wall flashings, wall connections
- Measurable: Working width 1000 mm

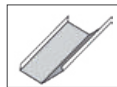

Item no. 91030000

Tile Edger Large Version

Application & Benefits

- Problem-free: Creation of tile edges in any desired sloping position to avoid leaks at corners
- Deep: 250 mm insertion depth
- Durable: By applying a high-quality powder coating

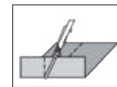

Item no. 91150000

Item no.	Version	Dimensions	Weight	PU
91040000	Sheet bending jaws, 102 BG 500, powder coated	500 mm	6.9 kg	1
91030000	Sheet bending jaws, 101 BG 1000, powder coated	1000 mm	11.8 kg	1
91150000	Tile edger, large version, 115 PEK, powder coated	250 mm	3 kg	1

Tile Edger Small Version

Application & Benefits

- Problem-free: Creation of tile edges in any desired sloping position to avoid leaks at corners
- Deep: 70 mm insertion depth
- Durable: By applying a high-quality powder coating

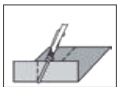

Item no. 91160000

Clipping Shears System 133 AKW

Application & Benefits

- Time-saving: Creation of a seam joint at eaves and facade end points
- Practical: AKW clips lower bead at the profiled panels and the upper bead only after the roof is completely covered



Item no. 91190000

Art. - Nr.	Version	Dimensions	Weight	PU
91160000	Tile edger, small version, 116 PEK, powder coated	70 mm	750 g	1
91190000	Clipping shears system in a box 133 AKW, powder coated	5000 mm	5 kg	1

Fliz-Folder

Application & Benefits

- Practical: For the production of pinched folds
- High quality: Made of high-quality stainless steel VA
- Useful: For upstands up to approx. 90° use wide side, for light upstands, use narrow side



Item no. 01131000

Flanging Tool

Application & Benefits

- Useful: For folding and stiffening of a sheet metal edge. Thereby the sheet metal edge is defused
- High quality: Forged tool
- Fine: Working surface highly polished
- Selection: 40 mm and 50 mm version available



Item no. 01030040

Seaming Iron Short Blade

Application & Benefits

- Traditional: For processing sheets in the standing seam technique
- High quality: Made of tool steel, forged
- Narrow: Working width of 100 mm - short blade
- Straight: Prism of 20 x 20 mm
- Drilled: Diameter 5 mm



Item no. 01150100

Item no.	Version	Dimensions	Weight	PU
01131000	Fliz-folder	140 x 120 mm	300 g	1
01030040	Flanging tool	40 mm	870 g	1
01030050	Flanging tool	50 mm	1.2 kg	1
01150100	Seaming iron short blade, 20 x 20 mm	100 mm	1.65 kg	1

Seaming Iron Long Blade

Application & Benefits

- Traditional: For processing sheets in the standing seam technique
- High quality: Made of tool steel, forged
- Narrow: Working width of 140 mm - short blade
- Straight: Prism of 25 x 25 mm
- Drilled: Diameter 5 mm



Item no. 01150000

Seaming Iron without Prisma

Application & Benefits

- Traditional: For processing sheets in the standing seam technique
- High quality: Made of tool steel, forged
- Wide: Working width of 140 mm - long blade
- Comfortable: With soft PVC handle



Item no. 01150001

Angle Flat Scraper

Application & Benefits

- Smooth: For smoothing and shaping of corners and edges in sheet metal working
- High quality: Made of tool steel, forged
- Clean: Working surfaces are brightly polished



Item no. 01120000

Item no.	Version	Dimensions	Weight	PU
01150000	Seaming iron long blade, 25 x 25 mm	140 mm	2.5 kg	1
01150001	Seaming iron without prisma with PVC handle	140 mm	1.9 kg	1
01120000	Angle flat scraper	290 mm	1.6 kg	1

Double Welt Iron for Square-Seam and Double Standing Seam

Application

Double folding ace: Creates angled and double standing seams in the field for non-pre-profiled panels!

Benefits & Comfort

- Practical: 12° beveled working surfaces of 25 mm and 35 mm
- Precise: Accurate seaming thanks to two parallel working surfaces
- Robust: Forged, high-quality, fully welded tool steel
- Simple: Quick and easy folding of the sheet metal
- Precise: Cleanly ground working surfaces for best results



Item no. 01110000

Item no.	Version	Dimensions	Weight	PU
01110000	Double welt iron for for square-seam and double standing seam	250 x 140 mm	3.2 kg	1



Because tradition never dies

With its two working surfaces, this robust, solid and stable folding iron ensures an outstanding performance.

Squeezing Folding Pliers

Application

Robust friend: For the creation of squeeze folds!

Benefits & Comfort

- Accurate: Precise folding of the corner due to cleanly machined inner edges
- Practical: Slot depth of 140 mm
- Durable: Made of high-quality tool steel and forged in one piece



Item no. 01130000

Item no.	Version	Dimensions	Weight	PU
01130000	Squeezing folding pliers, slot depth of 140 mm	200 x 170 mm	810 g	1



Because we like to go deep

And the squeezing folding pliers master this perfectly. It has a large insertion depth and can therefore be universally be used when creating squeeze folds.

Always Best Cuts



Straight



Notching



Smallest
Radii



Small
Radii Right



Small
Radii Left



Medium
Radii Right



Medium
Radii Left



Straight/L.
Radii Right



Medium
Radii Left

Pelican Snips

Application & Benefits

Fast cutter: Cuts sheets straight!

- Continuous: Makes meters quickly without bending up the sheet, thanks to pelican head shape
- Universal: For copper, zinc and aluminum
- Fast and precise: Proven cutting geometry and precise grinding



Item no. 01230300

Combination Snips

Application & Benefits

Sharp cutter: Cuts sheet metal straight and in larger radii!

- Clean and precise: Cutting geometry that has been proven for decades cuts the sheet metal without bending it
- Handy and insulated: The dip insulated PVC soft handle is absolutely slip-proof - more comfortable than bare metal



Item no. 01250260

Item no.	Version	Dimensions	Weight	PU
01230300	Pelican snips, right, HRC 56	300 mm	750 g	1
01230350	Pelican snips, right, HRC 56	350 mm	830 g	1
01231300	Pelican snips, left, HRC 56	300 mm	750 g	1
S1231300	Pelican snips, left, HCR 56, red handle	300 mm	750 g	1
01250260	Combination snips, right, HCR 56	260 mm	500 g	1
01251260	Combination snips, left, HCR 56	260 mm	500 g	1
S1251260	Combination snips, left, HCR 56, red handle	260 mm	500 g	1

Punch Snips

Application & Benefits

Agile cutter: Cuts sheets in medium radii!

- Clean and precise: Cutting geometry proven for decades
- Handy and insulated: The dip-insulated PVC soft handle is absolutely slip-proof - more comfortable than bare metal
- Maneuverable: Thanks to the short head shape



Medium Radii Right



Medium Radii Left



Item no. 01220250

Genuine Shape Cutting Snips

Application & Benefits

Agile cutter: Cuts sheets in smaller radii!

- Clean and precise: Cutting geometry proven for decades
- Safe: The clamping protection protects your hand
- Wear-resistant: Also suitable for zinc, copper and aluminum (hardened to HRC 56)



Small Radii Right



Small Radii Left



Item no. 01270250

Universal Snips

Application & Benefits

Universal divider: Cuts with fine blades!

- Clean and precise: Cutting geometry proven for decades
- Handy and insulated: The dip-insulated PVC soft handle is absolutely slip-proof - more comfortable than bare metal



Straight/L. Radii Right



Item no. 01240250

Item no.	Version	Dimensions	Weight	PU
01220250	Punch snips, right, HRC 56	250 mm	500 g	1
01220275	Punch snips, right, HRC 56	275 mm	550 g	1
01221250	Punch snips, left, HRC 56	250 mm	500 g	1
01221275	Punch snips, left, HRC 56	275 mm	550 g	1
01270250	Genuine shape cutting snips, right, HRC 56	250 mm	505 g	1
01271250	Genuine shape cutting snips, left, HRC 56	250 mm	505 g	1
01240250	Universal snips, right, HRC 56	250 mm	445 g	1

Berlin Pattern Snips

Application & Benefits

Berlin cutter: Cuts perfectly notches!

- Clean and precise: Cutting geometry proven for decades
- Handy and insulated: The dip-insulated PVC soft handle is absolutely slip-proof - more comfortable than bare metal
- Universal: For copper, zinc and aluminum



Notching



Item no. 01210250

Universal Snips

Application & Benefits

Universal divider: Cuts with wide and robust blade!

- Clean and precise: Cutting geometry proven for decades
- Handy and insulated: The dip-insulated PVC soft handle is absolutely slip-proof - more comfortable than bare metal
- Universal: For copper, zinc and aluminum



Straight/L.
Radii Right



Item no. 01260250

Roll-up Bag with Snips

Application & Benefits

Sheet metal pros: The universal scissors set!

- Ideal: Collection of the most important sheet metal snips
- Clean and precise: cutting geometry proven for decades
- Ready to use: In a practical roll-up bag



Straight



Straight/L.
Radii Right



Straight/L.
Radii Left



Item no. 04670074

Item no.	Version	Dimensions	Weight	PU
01210250	Berlin pattern snips, right, HRC 56	250 mm	450 g	1
01260250	Universal snips, HRC 56	250 mm	585 g	1
04670074	Roll-up bag with snips	400 mm	2 kg	1

Set includes:

1 x 01230300 Pelican snips right, 1 x 01250260 Combination snips right, 1 x 01251260 Combination snips left

Pelican Snips

Application & Benefits

Fast cutter: Cuts sheets straight!

- Continuous: Makes meters quickly without bending up the sheet, thanks to pelican head shape
- Wear resistant: Suitable also for stainless steel (hardened to HRC 59)
- Universal: For copper, zinc and aluminum, but also for stainless steel



Item no. 01232300

Combination Snips

Application & Benefits

Sharp cutter: Cuts sheet metal straight and in larger radii!

- Accurate: Cuts cleanly and precisely
- Wear-resistant: also suitable for stainless steel (hardened to HRC 59)
- Universal: For copper, zinc and aluminum, but also for stainless steel



Item no. 01252260

Item no.	Version	Dimensions	Weight	PU
01232300	Pelican snips, right, HRC 59	300 mm	750 g	1
01232350	Pelican snips, right, HRC 59	350 mm	785 g	1
01233300	Pelican snips, left, HRC 59	300 mm	750 g	1
01252260	Combination snips, right, HRC 59	260 mm	495 g	1
01252280	Combination snips, right, HRC 59	280 mm	600 g	1
01253260	Combination snips, left, HRC 59	260 mm	495 g	1
01253280	Combination snips, left, HRC 59	280 mm	600 g	1

Punch Snips

Application & Benefits

Precise cutter: Cuts sheet metal in medium radii!

- Everlasting: High-quality stainless steel (hardened to HRC 59) is also suitable stainless steel
- Clean and precise: Cutting geometry proven for decades
- Safe: The clamping protection protects your hand



Item no. 01222250

Genuine Shape Cutting Snips

Application & Benefits

Agile cutter: Cuts sheet metal in smaller radii!

- Clean and precise: Cutting geometry proven for decades
- Safe: The clamping protection protects your hand
- Wear-resistant: Also suitable for stainless steel (hardened to HRC 59)



Item no. 01272250

Item no.	Version	Dimensions	Weight	PU
01222250	Punch snips, right, HRC 59	250 mm	500 g	1
01222275	Punch snips, right, HRC 59	275 mm	550 g	1
01223250	Punch snips, left, HRC 59	250 mm	500 g	1
01223275	Punch snips, left, HRC 59	275 mm	550 g	1
01272250	Genuine shape cutting snips, right, HRC 59	250 mm	480 g	1
01273250	Genuine shape cutting snips, left, HRC 59	250 mm	480 g	1

Punch Snips with Curved Blades

Application & Benefits

Precise curve artist: Cuts smallest radii in sheet metal!

- Maneuverable: Thanks to their curved head shape and the rounded inner side
- Safe: Integrated pinch guard protects your hand
- Wear-resistant: Also suitable for stainless steel



Smallest Radii



Item no. 01224275

Roll Bag with Stainless Steel Snips

Application & Benefits

Powerful Cutter: The universal stainless steel snips set!

- Ideal: Collection of the most important sheet metal snips in stainless steel quality
- Clean and precise: Cutting geometry proven for decades
- Ready to go: In practical roll-up bag



Straight



Straight/L Radii Right



Straight/L Radii Left



Item no. 04670075

Pelican Snips

Application & Benefits

Fast cutter: Cuts sheets straight!

- Detectable: Right snips are green and left snips are red
- Continuous: Makes quick meters without bending up the sheet, thanks to pelican head shape
- Wear-resistant: Also suitable for stainless steel



Straight



Item no. S1232300

Item no.	Version	Dimensions	Weight	PU
01224275	Punch snips with curved blades, right, HRC 59	275 mm	550 g	1
01225275	Punch snips with curved blades, left, HRC 59	275 mm	550 g	1
04670075	Roll bag with stainless steel snips	400 mm	2 kg	1
Set includes:				
1 x 01232300 Pelican snips stainless steel right, 1 x 01252260 Combination snips stainless steel right, 1 x 01253260 Combination snips stainless steel left				
S1232300	Pelican snips, right, HRC 59	300 mm	730 g	1
S1232350	Pelican snips, right, HRC 59	350 mm	785 g	1

Combination Cutting Snips

Application & Benefits

Sharp cutter: Cuts sheet metal straight and in larger radii!

- Detectable: Right snips are green and left snips are red
- Wear resistant: Suitable for stainless steel (hardened to HRC 59)
- Universal: For copper, zinc and aluminum, but also for stainless steel



Color Variants



Straight/L. Radii Right



Straight/L. Radii Left



Item no. S1253260

Punch Snips with Curved Blades

Application & Benefits

Precise curve artist: Cuts smallest radii in sheet metal!

- Detectable: Right snips are green and left snips are red
- Maneuverable: Thanks to their curved head shape and the rounded inner side
- Wear-resistant: Also suitable for working on stainless steel



Color Variants



Smallest Radii



Item no. S1224275

Item no.	Version	Dimensions	Weight	PU
S1252260	Combination cutting snips, right, HRC 59, green	260 mm	495 g	1
S1252280	Combination cutting snips, right, HRC 59, green	280 mm	600 g	1
S1253260	Combination cutting snips, left, HRC 59, red	260 mm	495 g	1
S1253280	Combination cutting snips, left, HRC 59, red	280 mm	585 g	1
S1224275	Punch snips with curved blades, right, HRC 59, green	275 mm	500 g	1
S1225275	Punch snips with curved blades, left, HRC 59, red	275 mm	500 g	1

Pelican Snips

Application & Benefits

**Durable sharp HSS divider:
Cuts stainless steel sheets
straight!**

- Premium: Soldered HSS cutting edges (HRC 65)
- Perfect: When processing steel and stainless steel sheets, the HSS cutting edge stays sharp for a long time
- Continuous: Makes fast meters without bending up the sheet, thanks to pelican head shape



Item no. 01235300

Combination Cutting Snips

Application & Benefits

**Sharp HSS divider: Cuts
sheets straight and in larger
radii!!**

- Premium: Soldered HSS cutting edges (HRC 65)
- Perfect: When processing steel and stainless steel sheets, the HSS cutting edge stays sharp for a long time
- Continuous: Cuts the sheet metal straight and in larger radii, without bending the sheet metal



Item no. 01256280

Punch Snips

Application & Benefits

**Durable sharp HSS divider:
Cuts sheets in medium radii!**

- Premium: Soldered HSS cutting edges (HRC 65)
- Perfect: When processing steel and stainless steel sheets, the HSS cutting edge stays sharp for a long time
- Maneuverable: Thanks to the short head shape



Item no. 01228475

Item no.	Version	Dimensions	Weight	PU
01235300	Pelican snips, right, HRC 65	300 mm	690 g	1
01256280	Combination cutting snips, right, HRC 65	280 mm	600 g	1
01257280	Combination cutting snips, left, HRC 65	280 mm	600 g	1
01228475	Punch snips, right, HRC 65	275 mm	515 g	1
01229475	Punch snips, left, HRC 65	275 mm	515 g	1

Pelican Snips Longstyle Profil

Application & Benefits

**Longstyle professional:
Cuts sheets straight!**

- Fast and precise: Geometrically aligned cutting edges and precise grinding
- Clean: No bending of the sheet during the cutting process
- Ergonomic: Compound leverage and return spring saves energy when working



Item no. 01240251

Offset Cutting Snips

Application & Benefits

Durable cutter: Cuts sheet metal straight and in larger radii!

- Faster: 260 mm long scissors
- Ergonomic: Compound leverage and return spring saves energy when working
- Wear-resistant: Also suitable for stainless steel (hardened to HRC 60-62)



Item no. 01290260

Offset Snips

Application & Benefits

**American Cutter: Original
Midwest - Made in USA!**

- Clean: No bending of the sheet during the cutting process
- Ergonomic: Lever ratio and return spring save energy when working
- Comfortable: Ergonomic soft grip



Item no. 01341000

Item no.	Version	Dimensions	Weight	PU
01240251	Pelican snips longstyle profil, right, HRC 60-62	280 mm	450 g	1
01241251	Pelican snips longstyle profil, left, HRC 60-62	280 mm	450 g	1
01290260	Offset cutting snips, right, HRC 60-62	260 mm	545 g	1
01291260	Offset cutting snips, left, HRC 60-62	260 mm	545 g	1
01341000	Offset snips, right, HRC 56-57	225 mm	420 g	1
01342000	Offset snips, left, HRC 56-57	225 mm	420 g	1

Combination Cutting Snips

Compound Leverage

Application

Cool Cutter: Cuts sheets straight and in larger radii!



Friend
Choice



Color
Variants



Straight/L
Radii Right



Straight/L
Radii Left

Benefits & Comfort

- Ergonomic: Compound leverage and spring save energy when working
- Wear-resistant: Also suitable for processing stainless steel (hardened to HRC 60-62)
- Comfortable: Ergonomic 2K handle is absolutely slip-proof
- Fast and accurate: Proven cutting geometry and precise grinding
- Practical: The release comes off all by itself: Simply cut loose



Item no. 01290240

Item no.	Version	Dimensions	Weight	PU
01290240	 Combination cutting snips, compound leverage, right, HRC 60-62, green	240 x 80 mm	415 g	1
01291240	Combination cutting snips, compound leverage, left, HRC 60-62, green	240 x 80 mm	415 g	1
S1291240	Combination snips, compound leverage, left, HRC 60-62, red	240 x 80 mm	415 g	1



Because it is easier with a compound leverage

Therefore, depending on the radius, the combination snips can also make curves! And always fast, exact and so easy on the joints, that you can even cut through larger stainless steel surfaces. It cuts radii, but also straight ahead, without bending the sheet metal.

Shape and Straight Cutting Snips Compound Leverage

Application & Benefits

High-quality divider:
Cuts especially straight!

- Ergonomic: Compound leverage and return spring saves energy when working
- Wear-resistant: Also suitable for stainless steel (hardened to HRC 61)
- Straight: Well suited for straight cuts



Straight/L. Radii Right
Straight/L. Radii Left



Item no. 01294260

Offset Cutting Snips Compound Leverage

Application & Benefits

High quality divider:
Cuts straight and round!

- Ergonomic: Compound leverage and return spring saves energy when working
- Wear-resistant: Also suitable for stainless steel (hardened to HRC 61)
- Straight and round: Well suited for straight and round cuts



Straight/L. Radii Right
Straight/L. Radii Left



Item no. 01293260

Offset Cutting Snips Compound Leverage

Application & Benefits

Durably sharp HSS divider:
Cuts with compound leverage!

- Premium: Soldered-in HSS cutting edges (HRC 65)
- Perfect: When processing steel and stainless steel sheets, the HSS cutting edge stays sharp for a long time
- Ergonomic: Compound leverage and return spring



Straight/L. Radii Right
Straight/L. Radii Left



Item no. 01295260

Item no.	Version	Dimensions	Weight	PU
01294260	Shape and straight cutting snips, compound leverage, right, HRC 61	260 mm	510 g	1
01294261	Shape and straight cutting snips, compound leverage, left, HRC 61	260 mm	510 g	1
01293260	Offset cutting snips, compound leverage, right, HRC 61	260 mm	480 g	1
01293261	Offset cutting snips, compound leverage, left, HRC 61	260 mm	480 g	1
01295260	Offset cutting snips, compound leverage, right, stainless steel, HRC 65	260 mm	520 g	1
01295261	Combination snips, compound leverage, left, stainless steel, HRC 65	260 mm	520 g	1

Offset Cutting Snips Mini Compound Leverage

Application & Benefits

Short cutter: Handy offset cutting snips, ideal for radii!

- Handy: Short compound leverage offset cutting snips
- Ergonomic: Compound leverage and return spring saves power when working
- Comfortable: 2K soft grip



Straight/L. Radii Right



Straight/L. Radii Left



Item no. 01290180

Genuine Aviation Snips Compound Leverage

Application & Benefits

Exact cutter: Cuts small radii in sheet metal!

- Fast and precise: Proven cutting geometry and precise grinding
- Ergonomic: Compound leverage and return spring save energy when working
- Wear-resistant: Also suitable stainless steel



Color Variants



Small Radii Right



Small Radii Left



Item no. 01280260

Genuine Aviation Snips Compound Leverage

Application & Benefits

Exact cutter: Enables precise cuts!

- Fast and precise: Proven cutting geometry and precise grinding
- Ergonomic: Compound leverage and return spring save energy when working
- Wear-resistant: Also suitable for stainless



Notching



Item no. 01282240

Item no.	Version	Dimensions	Weight	PU
01290180	Offset cutting snips mini, compound leverage, right, HRC 61	180 mm	185 g	1
01290181	Offset cutting snips mini, compound leverage, left, HRC 61	180 mm	185 g	1
01280260	Genuine aviation snips, compound leverage, right, HRC 60-62	260 mm	475 g	1
01281260	Genuine aviation snips, compound leverage, left, HRC 60-62	260 mm	475 g	1
01282240	Genuine aviation snips, compound leverage, straight, HRC 60-62	260 mm	285 g	1

Genuine Aviation Snips Compound Leverage

Application

Exact blade: Cuts sheets in smaller radii!



Friend
Choice



Color
Variants



Small
Radii
Right



Small
Radii
Left

Benefits & Comfort

- Fast and precise: Proven cutting geometry and precise grinding
- Ergonomic: Compound leverage and return spring save energy when working
- Wear-resistant: Also suitable for processing stainless steel (hardened to HRC 60-62)
- Comfortable: Ergonomic 2K handle is absolutely slip-proof
- Safe: Locking latch ensures that the snips remain closed
- Practical: The release mechanism is self releasing: Simply start cutting



Item no. 01280240

Item no.	Version	Dimensions	Weight	PU
01280240	 Genuine aviation snips, compound leverage, right, HRC 60-62, green	240 mm	385 g	1
01281240	Genuine aviation snips, compound leverage, left, HRC 60-62, green	240 mm	385 g	1
S1281240	Genuine aviation snips, compound leverage, left, HRC 60-62, red	240 mm	385 g	1



Because you also have to make a cut sometimes

And please do it quickly, precisely and without damaging your joints. All this is what the aviation snips offer. In addition, they are very durable and, thanks to high-quality stainless steel, very wear-resistant. Thanks to the short design of the snips they fit perfectly in your hand.

Upright Snips Compound Leverage

Application & Benefits

Handy angle player: Positions your hand where it won't bother you!

- Maneuverable: Special shape with 90° angled head
- Ergonomic: Compound leverage and return spring save force when working
- Wear-resistant: High-quality tool steel (hardened to 60-62 HRC)



Color Variants



Straight/L. Radii Right



Straight/L. Radii Left



Item no. 01296200

Roll-up Bag with Genuine Aviation Snips Compound Leverage

Application & Benefits

Perfect divider: Practical set for roofers and drywallers!

- Ergonomic: Compound leverage and return spring
- Wear-resistant: High-quality stainless steel (hardened to HRC 60-62), also suitable for processing of stainless steel



Small Radii Right



Small Radii Left



Notching



Item no. 04670060

Roll Bag-Up with Offset Cutting Snips Compound Leverage

Application & Benefits

Practical divider: Set of 2 compound Offset cutting snips!

- Ergonomic: Compound Leverage and return spring saves power when working
- Wear-resistant: High-quality tool steel (hardened to HRC 60-62) is also suitable for processing of stainless steel



Straight/L. Radii Right



Straight/L. Radii Left



Item no. 04670059

Item no.	Version	Dimensions	Weight	PU
01296200	Upright snips, compound leverage, right, HRC 60-62	200 mm	450 g	1
01297200	Upright snips, compound leverage, left, HRC 60-62	200 mm	450 g	1
04670060	Roll bag-up with genuine aviation snips, compound leverage, HRC 60-62	300 mm	1.3 kg	1
Set includes:				
1 x 01280240 Genuine aviation snips right, 1 x 01281240 Genuine aviation snips left, 1 x 01282240 Genuine aviation snips straight				
04670059	Roll bag-up with offset cutting snips, compound leverage, HRC 60-62	300 mm	900 g	1

Set includes:

1 x 01290240 Offset cutting snips right, 1 x 01291240 Offset cutting snips left

Rolling Hand Shears HSG

Application & Benefits

Exact divider: Cuts sheets straight!

- Mobile: Cutting carriage incl. rolling knife and slim guide rail (working width 1000 mm)
- Practical: Cuts the sheets on the construction site simply from the coil. Fixes the rail on a pallet
- Convenient: Cutting carriage slides through the sheet metal



Item no. 91240000

Turbo Cutter Cordless Screwdriver Attachment

Application & Benefits

Machine cutter: Cuts sheets up to 1.32 mm!

- Durable: Low-wear knives for highest demands
- Strong: Sheets up to 1.32 mm and stainless steel up to 0.8 mm
- Flexible: Suitable for all cordless screwdrivers thanks to the adjustable clamping rail
- Fast: Very high cutting speed



Item no. 01202000

Nibbler Shears with Built-in Waste Curl Cutter

Application & Benefits

Nibbling cutter: Cuts deformation-free!

- Deformation-free: Nibble cut with 2.7 mm cutting width
- Strong: Sheet thickness of 1.2 mm and 0.6 mm for stainless steel
- Replaceable: Knife is replaceable



Item no. 01051000

Item no.	Version	Dimensions	Weight	PU
91240000	Rolling hand shears, include rolling shears, guiding rail and gloves	1110 mm	1.2 kg	1
Spare part:				
01202001	Turbo cutter replacement blades	90 mm	150 g	1
01202000	Turbo cutter cordless screwdriver attachment	160 mm	800 g	1
01051000	Nibbler shears with built-in waste curl cutter	275 mm	460 g	1

So You
Have
**The Hang
Of It**





HT
48032
DE-SN1

Coil Clamp Loop Pro

New

Only one click away. Integrated click function from the item image to our webshop.



Application

Cool Clip: The Loop Pro holds sheet metal coils up to 100 kilograms and makes unrolling and rewinding child's play, also ideal for storing multiple coils on a pallet!



Benefits & Comfort

- Lightweight and compact: Is very easy to carry and store thanks to its light weight. It is therefore ideal for use on construction sites
- Convenient: Opened coils can be stored super easily
- Strong and flexible: Holds coils up to max. 100 kg and adapts to the coil diameter (280-420 mm)
- Secure: Holds the coil in place, even without attaching the Loop Pro to the pallet



Item no. 04260000

Item no.	Version	Dimensions	Weight	PU
04260000	Coil clamp Loop Pro	490 x 390 x 40 mm	685 g	1



Because you've got the hang of it

Once the Loop Pro is fixed, everything goes very quickly. You can unroll or rewind the coil to the desired cut-off length in no time at all and with absolute safety. You don't have to readjust - the Loop Pro has everything under control.

**Lead Dresser
Symmetrical Shape
HDPE Plastic**

Application & Benefits

- Durable: Use of HDPE plastic
- Shaping: Flat symmetrical shape
- Use: For shaping of lead and zinc



Item no. 01960000

**Lead Dresser
Curved Shape
HDPE Plastic**

Application & Benefits

- Durable: Use of HDPE plastic
- Shaping: Oval-round shape
- Use: For shaping of lead and zinc



Item no. 01964000

**Lead Dresser
Straight Shape
HDPE Plastic**

Application & Benefits

- Durable: Use of HDPE plastic
- Shaping: Narrow tapered shape
- Use: For shaping of lead and zinc



Item no. 01963000

Item no.	Version	Dimensions	Weight	PU
01960000	Lead dresser, symmetrical shape, HDPE plastic	60 x 350 mm	730 g	1
01964000	Lead dresser, curved shape, HDPE plastic	60 x 330 mm	345 g	1
01963000	Lead dresser, straight shape, HDPE plastic	40 x 330 mm	320 g	1

Lead Dresser Assymetrical Shape HDPE Plastic

Application & Benefits

- Durable: Use of HDPE plastic
- Shaping: Flat asymmetric shape
- Use: For shaping of lead and zinc



Item no. 01961000

Lead Dresser Rounded Shape HDPE Plastic

Application & Benefits

- Shaping: Narrow rounded shape
- Use: For shaping of lead and zinc

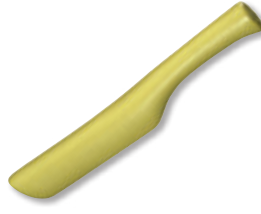

Item no. 01962000

Chase Wedge HDPE Plastic

Application & Benefits

- Durable: Use of HDPE plastic
- Shaping: Tapered shape
- Use: For shaping of lead and zinc



Item no. 01965000

Item no.	Version	Dimensions	Weight	PU
01961000	Lead dresser - lead stick, symmetrical shape, HDPE plastic	55 x 360 mm	525 g	1
01962000	Lead dresser - bossing stick, rounded shape, HDPE plastic	30 x 330 mm	320 g	1
01965000	Chase wedge, HDPE plastic	190 x 60 mm	150 g	1

Lead Dresser - Bossing Stick, Symmetrical Shape, Hardwood

Application & Benefits

- High quality: Precisely crafted hardwood
- Shaping: Flat symmetrical shape
- Use: For shaping of lead and zinc



Item no. 01940000

Lead Dresser - Bossing Stick, Round Curved Shape, Hardwood

Application & Benefits

- High quality: Precisely crafted hardwood
- Shaping: Oval-round shape
- Use: For shaping of lead and zinc



Item no. 01944000

Lead Dresser - Bossing Stick, Narrow, Rounded Shape, Hardwood

Application & Benefits

- High quality: Precisely crafted hardwood
- Shaping: Narrow rounded shape
- Use: For shaping of lead and zinc



Item no. 01942000

Item no.	Version	Dimensions	Weight	PU
01940000	Lead dresser - bossing stick, symmetrical shape, hardwood	60 x 350 mm	490 g	1
01944000	Lead dresser - bossing stick, round curved shape, hardwood	60 x 330 mm	295 g	1
01942000	Lead dresser - bossing stick, narrow, rounded shape, hardwood	60 x 360 mm	310 g	1

Chase Wedge Hardwood

Application & Benefits

- High quality: Precisely crafted hardwood
- Shaping: Tapered shape
- Use: For shaping of lead and zinc
- Choice: 2 sizes available (105 g and 240 g)



Item no. 01950000

Lead Dresser - Bossing Mallet Round, Hardwood

Application & Benefits

- High quality: Precisely crafted hardwood
- Shaping: Rounded hammer shape
- Use: For shaping of lead and zinc



Item no. 01930050

Triangle Bearing Scraper

Application & Benefits

- Scribing: For marking of metal surfaces
- Removing: For deburring metal sheets
- Handy: Ergonomic beech wood handle



Item no. 01350000

Item no.	Version	Dimensions	Weight	PU
01950000	Chase wedge, hardwood, small	60 x 185 mm	105 g	1
01951000	Chase wedge, hardwood, big	90 x 220 mm	240 g	1
01930050	Lead dresser - bossing mallet round, hardwood	50 x 110 mm	180 g	1
01350000	Triangle bearing scraper	200 mm	165 g	1

Zinc Scriber Hardened Tip

Application & Benefits

Long scriber: Marks and scribes zinc sheets reliably!

- Scribing: For marking of metal surfaces
- Handy: Ergonomic beech wood handle
- Hard: Durable hardened marking tip



Item no. 01300000

Zinc Scriber Carbide Tip

Application & Benefits

Convenient cutter: For scribing and cutting of zinc sheets!

- Permanently sharp: Soldered-in carbide tip
- Powerful: Good power transmission due to special shape
- Handy: Ergonomic beech wood handle



Item no. 01300100

Files for Soft Metals

Application & Benefits

Practical deburrer: Processes zinc and other soft metals reliably!

- Forming: Flat die
- Handy: Ergonomic beech wood handle
- Durable: Use of high quality file steel



Item no. 01380000

Item no.	Version	Dimensions	Weight	PU
01300000	Zinc scriber, hardened tip	280 mm	170 g	1
01300100	Zinc scriber, carbide tip	160 mm	150 g	1
01380000	Files for soft metals	210 mm	120 g	1

Sheet Metal Contractor Box for Construction Site Use

Application & Benefits

Box equipped with 27 Freund quality tools.
Light and sturdy aluminum box.
With 5 mm hardboard insert, lockable!



Item no. 04601000

Item no.	Version	Dimensions	Weight	PU
04601000	Sheet metal contractors box, 27 pieces	550 x 260 x 300 mm	30 kg	1
Set includes:				
NE460000	Sheet metal contractor box for construction site use	575 mm	3.25 kg	1
01080060	Seaming pliers, straight, lap joint	60 mm	700 g	1
01090060	Seaming pliers, 45°, lap joint	60 mm	700 g	1
01092060	Seaming pliers, 90°, lap joint	60 mm	750 g	1
01252280	Combination snips, right, HRC 59	280 mm	600 g	1
01253280	Combination snips, left, HRC 59	280 mm	585 g	1
01370240	Flat nose pliers, lap joint	240 mm	440 g	1
01360240	Round nose pliers, lap joint	240 mm	450 g	1
01430030	Chisel	30 mm	225 g	1
01883000	Locksmith square	250 mm	300 g	1

It's all in there

Item no.	Version	Dimensions	Weight	PU
01710300	Locksmith's hammer	290 mm	300 g	1
01710500	Locksmith's hammer	345 mm	500 g	1
01676000	Wooden hammer	60 x 140 mm	370 g	1
05660250	Bow compass	250 mm	250 g	1
01674000	Tinman's hammer, PVC	85 x 40 x 150 mm	550 g	1
00102001	Roofer's hammer without magnet	320 mm	600 g	1
01551000	Scriber with carbide tip	250 mm	35 g	1
01320002	Pipe crimper	245 mm	495 g	1
00782000	Metal saw bow with 2K-Handle	300 mm	815 g	1
01890400	Spirit level aluminium	400 mm	250 g	1
01132000	Scribing plate, straight form, mm scale	140 mm	65 g	1
01130000	Squeezing folding pliers, depth 140 mm	200 x 170 mm	850 g	1
01331000	Vise-grip pliers-locking pliers with PVC-Protection	200 mm	790 g	1
01310000	Gesipa hand riveter NTX	260 mm	575 g	1
01070250	Seam opening pliers, lap joint	30 mm	450 g	1
00864000	Multi purpose saw, 7 tpi	400 mm	330 g	1
02982050	Masonry cord	50 m	75 g	1

Assembly Equipment Box for Construction Site Use

Application & Benefits

Box equipped with 47 Freund quality tools.
Light and sturdy aluminum box.
With 5 mm hardboard insert, lockable!



Item no. 04611000

Art.-Nr.	Version	Dimensions	Weight	PU
04611000	Assembly equipment box, 47 pieces:	550 x 260 x 300 mm	66 kg	1
Set includes:				
NE461000	Sheet Metal Contractor box for den construction site use	895 mm	5.75 kg	1
00760300	Hacksaw for For pipes and gutters	300 mm	450 g	1
00782000	Metal saw bow with 2K-Handle	300 mm	815 g	1
00832000	Metal saw bow with pistol handle	300 mm	465 g	1
01000600	Gutter hanger bender	600 mm	3.2 kg	1
01030040	Flanging tool	40 mm	870 g	1
01070250	Seam opening pliers, lap joint	30 mm	450 g	1
01080060	Seaming pliers, straight, lap joint	60 mm	700 g	1
01090060	Seaming pliers, 45°, lap joint	60 mm	700 g	1
01092060	Seaming pliers, 90°, lap joint	60 mm	750 g	1

It's all in there

Item no.	Version	Dimensions	Weight	PU
01100081	Squeezing folding pliers, lap joint	80 mm	800 g	1
01110000	Double welt iron for squareseam and double standing seam	140 mm	3.4 kg	1
01120000	Angle flat scarper	290 mm	1.6 kg	1
01121000	Hammer	120 mm	300 g	1
01130000	Squeezing folding pliers, slot depth 140 mm	200 x 170 mm	850 g	1
01132000	Scribing plate, straight form, mm scale	140 mm	65 g	1
01150000	Seaming iron with prisma 25 x 25 mm	280 mm	2.5 kg	1
01160140	Seaming pliers, curved, staked joint	140 mm	2 kg	1
01170060	Corner clinching pliers, lap joint	60 mm	1.3 kg	1
01222275	Punch snips, right, HRC 59	275 mm	500 g	1
01223275	Punch snips, left, HRC 59	275 mm	500 g	1
01224275	Punch Snips with curved blades, right, HRC 59	275 mm	500 g	1
01225275	Punch Snips with curved blades, left, HRC 59	275 mm	500 g	1
01232300	Pelican Snips, right, HRC 59	300 mm	730 g	1
01252280	Combination Snips, right, HRC 59	280 mm	600 g	1
01253280	Combination Snips, left, HRC 59	280 mm	585 g	1
01310000	Gesipa-hand riveter NTX	260 mm	575 g	1
01320002	Pipe crimper	245 mm	495 g	1
01331000	Vise-grip pliers with PVC-Protection	200 mm	790 g	5
01360240	Round nose pliers, lap joint	240 mm	450 g	1
01370240	Flat nose pliers, lap joint	240 mm	440 g	1
01380000	Files for soft metals	250 mm	330 g	1

It's all in there

Item no.	Version	Dimensions	Weight	PU
01430030	Chisel	30 mm	225 g	1
01650000	Water pump pliers	240 mm	290 g	1
01670032	Deadblow hammer	350 mm	600 g	1
01674000	Tinman's hammer, PVC	85 x 40 x 150 mm	550 g	1
01676000	Wooden hammer	60 x 140 mm	370 g	1
01691400	Grooving hammer	340 mm	400 g	1
01710300	Locksmith's hammer	290 mm	300 g	1
01710500	Locksmith's hammer	345 mm	500 g	1
01883800	Carpenter's square, powder coated	800 x 320 mm	420 g	1
01890001	Spirit level	90 mm	15 g	1
01890800	Spirit level, aluminium	800 mm	460 g	1
02982050	Masonry cord	50 m	75 g	1
05660250	Bow compass	250 mm	250 g	1
91070000	Edge roller, 105 TK, powder coated	250 mm	1.7 kg	1
91080000	Eave closer , 106 TSCH, powder coated	400 mm	2.1 kg	1
91100000	Square-seam folder, 111 WFSC, powder coated	220 mm	2 kg	1
91170000	Double standing seam closer , 117 WDF, powder coated	475 mm	2.3 kg	1

Tinman's hammer, PVC Angular with Pointed Head

Application

Solid performer: Gives sheet metal gently a shape!



Benefits & Comfort

- Flexible: One wide (40 x 85 mm) and one narrow (10 x 85 mm) working surface with a head length of 150 mm.
- Robust and wear-resistant: High-quality plastic head with rounded edges, which is milled as a whole from the block
- Durable and stable: By using an ash handle, optionally this hammer is also available with a hickory handle
- Safe: Ring wedge and handle safety with stainless steel screw in the head
- Ergonomic: Good balance between head and handle for fatigue-free work



Item no. 01674000

Item no.	Version	Dimensions	Weight	PU
01674000	 Tinman's hammer, PVC, angular with pointed head	380 x 150 mm	510 g	1
01684000	Tinman's hammer, PVC, angular with pointed head, hickory	380 x 150 mm	540 g	1



Because it should get into the corners

That is why this plastic hammer has a pointed head! It is gently on the material, and at the same time light in the hand, is robust and reliable. Also because its weight is optimally balanced between head and handle.

Tinman's Hammer, PVC Angular

Application & Benefits

Stable performer: Gives sheets gently a shape!

- Robust and wear resistant: High-quality plastic head with rounded edges, which is milled as a whole from the block
- Durable and stable: Through use of an ash handle, optionally this hammer is also with a hickory handle available
- Safe: Ring wedge and handle safety
- With stainless steel screw in the head



Item no. 01678145

Tinman's Hammer, PVC Round

Application & Benefits

Gentle beater: Gives sheet metal gently a shape!

- Robust and wear-resistant: High-quality round plastic head with rounded edges, which is milled as a whole from the block
- Durable and stable: Through use of an ash handle
- Ideal: Rounded edges of the plastic head protect the material



Item no. 01678060

Item no.	Version	Dimensions	Weight	PU
01678145	Tinman's hammer, PVC, angular, small version	145 x 35 mm	550 g	1
01678155	Tinman's hammer, PVC, angular, big version	155 x 35 mm	600 g	1
01688145	Tinman's hammer, PVC, angular, hickory handle	145 x 35 mm	550 g	1
01678060	Tinman's hammer, PVC, round	Ø 60 x 108 mm	450 g	1

Deadblow Hammer

Application & Benefits

Gentle beater: For careful work without rebound!

- On the point: The rebound is prevented through a filled hammer head
- High quality: Handle and head permanently connected
- Durable: Through the use of hickory wood



Item no. 01670032

Soft Face Hammer

Application & Benefits

Gentle beater: Processes materials with sensitive surfaces!

- Protective: The plastic heads made of cellulose acetate do not leave abrasion marks on the surface
- Safe: High-quality connection of head and handle by ring wedge
- Pleasant and durable: Ash handle is short-fibred, elastic and reduces the vibrations when hitting
- Practical: Hammer handle and plastic heads (Ø 30 mm) are exchangeable



Item no. 01671000

Item no.	Version	Dimensions	Weight	PU
01670032	Deadblow hammer, Ø 32 mm	350 mm	600 g	1
01670040	Deadblow hammer, Ø 40 mm	375 mm	820 g	1
01670050	Deadblow hammer, Ø 50 mm	385 mm	1.2 kg	1
01671000	Soft face hammer, Ø 30 mm	280 mm	320 g	1

Wooden Hammer with Metal Ring

Application & Benefits

Durable beater: Sturdy metal ring keeps the hammer head protected!

- Durable and stable: Through use of a handle made of ash wood
- Robust and wear-resistant: High-quality processed hardwood head



Item no. 01676000

Wooden-Tinman's Hammer Angular with Pointed Head

Application & Benefits

Perfect shaper: Gives sheets gently a shape!

- Flexible: One wide angular and a narrow angular work surface
- Durable and solid: Due to use of a handle made of ash wood
- Robust and wear-resistant: High-quality crafted hardwood head



Item no. 01673000

Wooden-Tinman's Hammer Round with Pointed Head

Application & Benefits

Ideal shaper: Gives sheet metal gently a shape!

- Flexible: One large round and a narrow work surface
- Durable and stable: Through use of a handle made of ash wood
- Robust and wear-resistant: High-quality crafted Hardwood head



Item no. 01672000

Item no.	Version	Dimensions	Weight	PU
01676000	Wooden hammer with metal ring	Ø 60 mm	370 g	1
01677000	Wooden hammer with metal ring	Ø 70 mm	560 g	1
01673000	Wooden-tinman's hammer, angular with pointed head	90 x 50 x 165 mm	580 g	1
01672000	Wooden-tinman's hammer, rund with pointed head	Ø 80/160 mm	550 g	1

Grooving Hammer

Application

Gentle beater: Gives sheet metal gently a shape!



Benefits & Comfort

- Twisted: The hammer has 2 striking directions, simply turn the hammer handle
- High quality: The hitting surface is polished and the head is precisely ground - disturbing burrs are no longer a problem
- Robust: Due to the use of a hardwood handle
- Ergonomic: Good balance between head and handle for fatigue-free work
- Safe: Ring wedge in the head



Item no. 01691400

Item no.	Version	Working width	Dimensions	Weight	PU
01691400	Grooving hammer	A = 10 mm B = 30 mm	330 x 130 mm	380 g	1

Because you don't have to twist with this hammer

Because the grooving hammer has two striking directions for you. The forged head is very high quality workmanship, precisely ground and the striking surfaces are cleanly polished - almost a work of art.

Hammer for Angle Flat Scraper

Application & Benefits

Solid shaper: Thanks to sturdy hardwood handle!

- Gentle: Polished striking surface, high quality forged head and precise grinding - does not leave any burrs
- Compact: For shaping corners with the angle flat scraper
- Safe: Ring wedge in the head for best handling



Item no. 01121000

Shrinking Hammer with Flat Surfaces Two-Headed

Application & Benefits

Variable shaper: With round and square striking surface!

- Robust: Thanks to sturdy hardwood handle
- Gentle: Polished striking surface, high-quality forged head and precise grinding does not leave any burrs
- Safe: Ring wedge in the head for best handling



Item no. 70600300

Shrinking Hammer with Different Faces

Application & Benefits

Variable shaper: With differently curved round striking surfaces!

- Robust: Thanks to sturdy hardwood handle
- Gentle: Polished striking surface, high-quality forged head and precise grinding do not leave any burrs
- Safe: Ring wedge in the head for best handling



Item no. 70620300

Item no.	Version	Working width	Dimensions	Weight	PU
01121000	Hammer for angle flat scraper	A = 22 mm B = 4 mm	120 mm	300 g	1
70600300	Shrinking hammer two-headed, with flat surfaces	A = 27 mm B = 25 mm	105 mm	300 g	1
70620300	Shrinking hammer, with different faces	A = 23 mm B = 24 mm	135 mm	300 g	1

Grooving Hammer Two-Headed

Application & Benefits

Variable: With 2 different curved faces!

- Robust: Thanks to sturdy hardwood handle
- Gentle: Polished striking surface, high-quality forged head and precise grinding does not leave any burrs
- Safe: Ring wedge in the head for best handling



Item no. 70650300

Polishing Hammer Two-Headed

Application & Benefits

Variable: With one round flat and one one round high curved face!

- Robust: Thanks to sturdy hardwood handle
- Gentle: Polished striking surface, high-quality forged head and precise grinding does not leave any burrs
- Safe: Ring wedge in the head for best handling



Item no. 70710750

Planishing and Grooving Hammer Two-Headed

Application & Benefits

Variable: With one round flat and one one round high curved face!

- Robust: Thanks to sturdy hardwood handle
- Gentle: Polished striking surface, high-quality forged head and precise grinding does not leave any burrs
- Safe: Ring wedge in the head for best handling



Item no. 70750400

Item no.	Version	Working width	Dimensions	Weight	PU
70650300	Grooving hammer, two-headed	A = 12 mm B = 14 mm	120 mm	300 g	1
70710750	Polishing hammer, two-headed	A = 37 mm B = 37 mm	130 mm	750 g	1
70750400	Planishing and grooving hammer, two-headed	A = 30 mm B = 23 mm	105 mm	400 g	1

Locksmith's Hammer with Wooden Handle

Application & Benefits

Solid shaper: Thanks to sturdy hardwood handle!

- Safe: Manufactured according to DIN 1041
- Durable: Curved ash wood handle
- Fixed: Wooden handle is fixed with an oval wedge in the hammer head
- Selection: Different hammer head sizes to choose from



Item no. 01710200

Assembly Hammer with Steel Tube

Application & Benefits

- High quality: Forged hammer head
- Safe: Additional steel ring as handle safety
- Comfortable: Soft grip made of soft PVC



Item no. 01720301

Rubber Hammer with Wooden Handle

Application & Benefits

- Durable: Tapered hardwood handle, thereby securely attached to the head
- Qualitative: Manufactured according to DIN 5128
- Gentle: Hammer head made of impact-resistant hard rubber



Item no. 01670000

Item no.	Version	Dimensions	Weight	PU
01710200	Locksmith's hammer with wooden handle	280 mm	200 g	1
01710300	Locksmith's hammer with wooden handle	290 mm	300 g	1
01710400	Locksmith's hammer with wooden handle	305 mm	400 g	1
01710500	Locksmith's hammer with wooden handle	345 mm	500 g	1
01711500	Locksmith's hammer with wooden handle	375 mm	1.5 kg	1
01720301	Assembly hammer with steel tube handle	280 mm	300 g	1
01670000	Rubber hammer with wooden handle	65 mm	300 g	1

Gutter Hanger Bender Transfor.Maxx

Application

Ergonomic single-handed tool: Bends gutter hangers with a clamping range up to 8 millimeters!

Benefits & Comfort

- Stable: Non-slip rubberized foot step
- Precise: Strong magnetic locking device for right-angled bending of the gutter hangers
- Flexible: Telescoping steel tubes (600, 700, 800 mm) for nine working positions and different body sizes as well as adjustable leverage
- Mobile: Small pack size for easy transport and storage
- Precise: Bending angle is continuously adjusted with fine-thread screw



Item no. 01000900

Item no.	Version	Dimensions	Weight	PU
01000900	Gutter hanger bender Transfor.Maxx	650 x 130 mm	4.6 kg	1

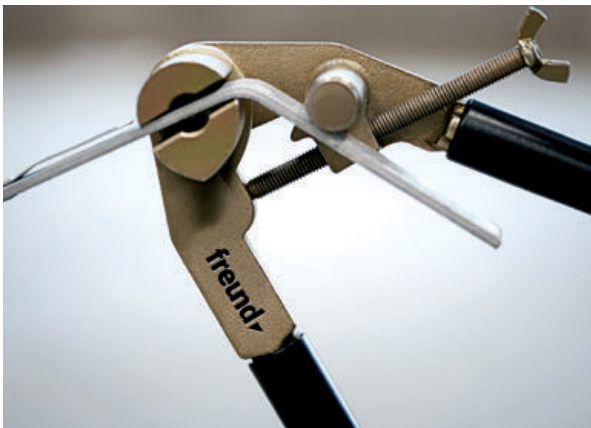

Because it also works one-handed

Because the Transfor.Maxx makes it possible to angle or bend with just one hand. For better leverage the gutter hanger bender is fixed with the foot for better leverage. Result: Very ergonomic, absolutely precise work.

Gutter Hanger Bender

Application

Iron Lady: Bends gutter hangers with a clamping range up to 8 millimeters!



Benefits & Comfort

- Flexible: Available in two versions, 600 and 800 mm
- Accurate: Precisely manufactured pliers head for exact bends
- Exact: Bending angle is infinitely variable with fine-thread screw
- Ergonomic: Ribbed PVC handle fits perfectly in your hand



Item no. 01000600

Item no.	Version	Dimensions	Weight	PU
01000600	 Gutter hanger bender	600 x 120 mm	3.4 kg	1
01000800	Gutter hanger bender	800 x 120 mm	3.5 kg	1



Because sometimes you have to twist

With the gutter hanger benders you angle and bend gutter hangers up to a thickness of 8 mm without any problems. Thanks to the integrated threaded screw, the angle is infinitely adjustable. The newly designed head ensures precise bends - just as you need it.

Gutter Adjustment Pliers

Application

Tough fixer: Re-aligns bent gutter hangers!

Benefits & Comfort

- Universal: Aligns six- to eight-section half-round and box gutters thanks to rotatable gutter hanger holder (also for spring and nose)
- Protective: Force is only transmitted to the gutter hanger, the gutter is not damaged
- Comfortable: Super handling thanks to ergonomic plastic handle
- Power-saving: Thanks to excellent leverage effect
- Durable: High-quality welding and bright zinc plating



Item no. 01010000

Item no.	Version	Dimensions	Weight	PU
01010000	Gutter adjustment pliers	710 x 120 mm	1.7 kg	1

Because someone has to fix it

Especially after long winters with lots of snow. With the gutter adjustment pliers you quickly and easily straighten bent gutter hangers. And on top of that, you save a lot of time. Because for the alignment of the gutter hangers you do not even have to remove the gutter.

Pipe Crimper Compound Leverage

Application & Benefits

Practical tube reducer: Leverage and 52 mm insertion depth!

- Practical: Reduction of the pipe diameter by reduction of the upper downpipe
- Deep: Insertion depth of 52 mm
- Smooth running: Through compound leverage
- Numerous: Works with 5 reducing blades



Item no. 01320001

Pipe Crimper Straight

Application & Benefits

Handy pipe reducer: Pliers with 5 and 30 mm insertion depth!

- Practical: Reduction of the pipe diameter by reduction of the upper downpipe
- Deep: Insertion depth of 52 mm
- Numerous: Works with 5 reducing blades



Item no. 01320002

Pipe Crimper Curved

Application & Benefits

Bent pipe reducer: 45° angled for more ergonomics!

- Practical: Reduction of the pipe diameter by reduction of the upper downpipe
- Deep: Insertion depth of 52 mm
- Ergonomic: bent pliers head for easier work
- Numerous: Works with 5 reducing blades



Item no. 01320003

Item no.	Version	Insertion depth	Dimensions	Weight	PU
01320001	Pipe crimper, compound leverage	52 mm	265 mm	740 g	1
01320002	Pipe crimper, straight	30 mm	245 mm	495 g	1
01320003	Pipe crimper, curved	40 mm	265 mm	500 g	1



**Practical,
Flexible and
Voluminous**

Gutter Cleaning Kit

Application

Unbeatable team: For fast and easy gutter cleaning with few ladder movements!

Benefits & Comfort

- Space-saving: Mountable extension bar (3-piece), especially suitable for transport
- Practical: You want to have your hands free? Simply hang the gutter rake on the gutter with the integrated hook
- Flexible: The narrow and adaptable tip of the scoop adapts to any gutter size
- Safe and voluminous: The gutter scoop can really hold a lot and thanks to the high side walls almost nothing gets lost



Item no. 00452000

Item no.	Version	Dimensions	Weight	PU
00452000	Gutter cleaning kit	490 mm	575 g	1
Set includes:				
00450000	Gutter scoop Flinker Freund	450 mm	100 g	1
00451000	Gutter Grabber + Gutter rake 120 cm steel extension bar	160 mm	350 g	1

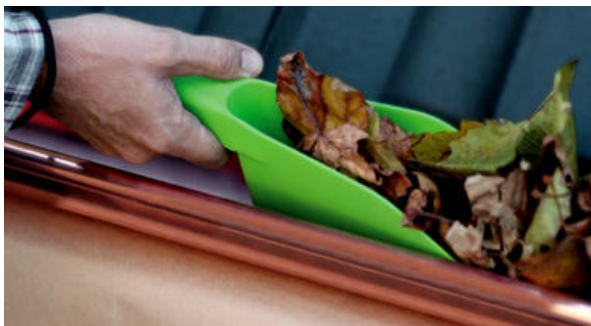

Because gutter cleaning can be so easy

With this set you are more than prepared for the autumn. The powerful combination of the gutter scoop and the gutter rake with additional extension rod makes gutter cleaning child's play! Simply connect them and off you go. Forget the hassle of moving the ladder, with this work aid you have an extended action radius of 2.5 meters to the right and left.

One
For All





**No Matter What
- Everything
Is Always There**

6D Pipe Expander in a Set

New

Only one click away. Integrated click function from the item image to our webshop.



Application

Powerful all-rounder: One for six. Expands all standard downpipes, no matter what size!

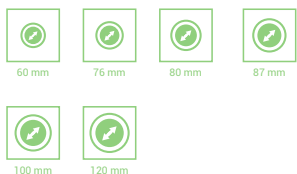

Benefits & Comfort

- All-in-one: Easy adaptation to all standard dimensions. One tool, 6 diameters
- Complete: Everything is included in the set - no unnecessary searching
- Gentle on materials: Easy to expand, almost without marks
- Runs: Pulls itself in – automatic propulsion
- Effortless: Little force required when expanding and holding the pipe
- Cordless: Works with a standard cordless screwdriver



Item no. 02320000

Item no.	Version	Dimensions	Weight	PU
02320000	6D pipe expander in a set Ø 60/76/ 80/ 87/ 100/ 120 mm	450 mm	3.05 kg	1



Because one can do everything

And this one really convinces. No more unnecessary compromises. With the new 6D all-in-one pipe expander, you'll be ready for any eventuality equipped for any eventuality. No matter which pipe diameter you face, with this set you can easily achieve top results. And that without stress and without much effort - pipe expanders for everyone.

Gutter Adjustment Pliers Universal

Application & Benefits

Practical Fixer: Aligns bent gutter hangers!

- Option 1: 3-piece complete set for 6- to 8-pcs. half-round and box gutters (only for spring and nose)
- Option 2: Pliers for 6- to 7-pcs. half-round and box gutters (for spring and nose only)
- Maneuverable: Also suitable for narrow gutters, thanks to the open head design
- Protective: Force is only transferred to the hanger, the gutter is not getting damaged



Item no. 01020000

Pipe Expander

Application & Benefits

Shaping specialist: Widens all commercially welded downpipes!

- Lifetime: Hardened and burnished special steel
- Low maintenance: Simple operating principle without gears
- Proven: Hexagonal mount for chuck of the cordless screwdriver
- Selection: Several versions from 60 - 120 mm available



Item no. 01320060

Item no.	Version	Dimensions	Weight	PU
01020000	Gutter adjustment pliers, universal, set for 6- to 8-pcs.	750 mm	3.9 kg	1
01026000	Gutter adjustment pliers, universal, set for 6- to 7-pcs.	750 mm	2.3 kg	1
01320060	Pipe expander	Ø 60 mm	965 g	1
01320076	Pipe expander	Ø 76 mm	1.4 kg	1
01320080	Pipe expander	Ø 80 mm	1.5 kg	1
01320087	Pipe expander	Ø 87 mm	1.8 kg	1
01320100	Pipe expander	Ø 100 mm	2.2 kg	1
01320120	Pipe expander	Ø 120 mm	3 kg	1

Pipe Expander in a Set 87/100 mm

Application & Benefits

Shaping specialist: Widens all commercially welded downpipes!

- Fixed: Metal case for max. 3 expanders, which are thanks to the movement-free inside locked
- Lifetime: Hardened and burnished special steel
- Low maintenance: Simple operating principle without gears
- Proven: Hexagonal mount for chuck of the cordless screwdriver



Item no. 01329006

Pipe Expander in a Set 80/100 mm

Application & Benefits

Shaping specialist: Widens all commercially welded downpipes!

- Fixed: Metal case for max. 3 expanders, which are thanks to the movement-free inside locked
- Lifetime: Hardened and burnished special steel
- Low maintenance: Simple operating principle without gears
- Proven: Hexagonal mount for chuck of the cordless screwdriver



Item no. 01329008

Pipe Expander in a Set 100/120 mm

Application & Benefits

Shaping specialist: Widens all commercially welded downpipes!

- Fixed: Metal case for max. 3 expanders, which are thanks to the movement-free inside locked
- Lifetime: Hardened and burnished special steel
- Low maintenance: Simple operating principle without gears
- Proven: Hexagonal mount for chuck of the cordless screwdriver



Item no. 01329010

Item no.	Version	Dimensions	Weight	PU
01329006	Pipe expander in a set 87/100 mm	360 x 135 x 95 mm	7.5 kg	1
01329008	Pipe expander in a set 80/100 mm	360 x 135 x 95 mm	7.3 kg	1
01329010	Pipe expander in a set 100/120 mm	360 x 135 x 95 mm	8.8 kg	1

Pipe Expander in a Set 87/100/120 mm

Application & Benefits

Shaping specialist: Widens all commercially welded downpipes!

- Fixed: Metal case for max. 3 expanders, which are thanks to the movement-free inside locked
- Lifetime: Hardened and burnished special steel
- Low maintenance: Simple operating principle without gears
- Proven: Hexagonal mount for chuck of the cordless screwdriver



Item no. 01329001

Pipe Expander in a Set 76/87/100 mm

Application & Benefits

Shaping specialist: Widens all commercially welded downpipes!

- Fixed: Metal case for max. 3 expanders, which are thanks to the movement-free inside locked
- Lifetime: Hardened and burnished special steel
- Low maintenance: Simple operating principle without gears
- Proven: Hexagonal mount for chuck of the cordless screwdriver



Item no. 01329003

Item no.	Version	Dimensions	Weight	PU
01329001	Pipe expander in a set 87/100/120 mm	360 x 135 x 95 mm	10 kg	1
01329003	Pipe expander in a set 76/87/100 mm	360 x 135 x 95 mm	9 kg	1

Automatic Soldering Iron with Piezo Ignition

Application & Benefits

Wind protected burner: Soldering Iron with wind protection and ignition!

- Wind protected: Through patented combustion chamber system
- Circular burning: Flame surrounds the copper piece from all sides
- Sustainable: Reduced gas consumption
- Rotatable: Copper piece 360° rotatable and 10° in inclination adjustable and rotatable hose connection
- Ignitable: Integrated piezo ignition



Item no. 66434000

Soldering Iron with Combustion Chamber

Application & Benefits

Circular burner: Soldering iron with windscreen!

- Wind protected: Through patented combustion chamber system
- Circular burning: Flame surrounds the copper tip from all sides
- Sustainable: Reduced gas consumption
- Rotatable: Copper piece 360° rotatable and 10° in inclination adjustable and rotatable hose connection



Item no. 66432001

Soldering Set in a Metal Case

Application & Benefits

Perfect soldering case for repairs: With cartridge soldering iron and accessories!

- Hose-less: Soldering iron is powered by gas cartridge
- Wind protected: Due to patented combustion chamber system
- Circular burning: Flame surrounds the copper piece from all sides
- Sustainable: Reduced gas consumption for burning time of 1-2 h
- Rotatable: Copper piece 360° rotatable and 10° in inclination adjustable and rotatable hose connection
- Ignitable: Integrated piezo ignition



Item no. 66440000

Item no.	Version	Dimensions	Weight	PU
66434000	Automatic soldering iron with piezo ignition	340 mm	1 kg	1
66432001	Soldering iron with combustion chamber	340 mm	900 g	1
66440000	Soldering set in a metal case	360 mm	3.1 kg	1

Set includes:

1 x 66444000 Automatic soldering iron, 2 x 64440086 High performance spare gas cartridge cartridge, 1 x 03331000 Bottle for soldering fluid, 1 x 03390002 Soldering brush, 1 x Protection tube for used brushes, 1 x Ammonia stone in metal box

Soldering Iron with Piezo Ignition incl. Gas Cartridge

Application & Benefits

Self contained burner: Soldering iron without hose - ideal for repairs!

- Hose-less: Soldering iron is powered by a gas cartridge
- Wind protected: Through patented combustion chamber system
- Circular burning: Flame surrounds the copper piece from all sides
- Sustainable: Reduced gas consumption for burning time of 1-2 h
- Rotatable: Copper piece 360° rotatable and 10° in inclination adjustable and rotatable hose connection
- Ignitable: Integrated piezo ignition



Item no. 66444000

Hot Air Gun with Gas Cartridge

Application & Benefits

Hot air blower: Ideal for sheet metal work in the winter!

- Adjustable: From 420° C - 1650° C
- Hose-free and cordless: For flat roof repairs (Bitumen, PVC, EPDM etc.)
- Winter: Ideal for preheating of zinc at cold temperatures
- Packed: Delivered in practical plastic case with foam insert
- Enduring: 1.5 h working time
- Overhead: Works in all positions



Item no. 66510000

Item no.	Version	Dimensions	Weight	PU
66444000	Soldering iron with piezo ignition incl. gas cartridge	360 mm	1 kg	1
66510000	Hot air gun with gas cartridge and 2 attachments: reflector and flat nozzle	260 mm	560 g	1

Gas Cartridge Powergas

Application & Benefits

**Winter-hard energy supplier:
Supplies the soldering iron
1 to 2 h burning time!**

- Winter resistant: Due to high propene admixture (26 %) improved for winter use
- Enduring: 1-2 h burning time with self contained soldering iron
- Energetic: Butane, Propane and propene
- Upside down: Thanks to special foam suitable for overhead operation



Item no. 64440086

Soldering Iron Tip Pointed Shape

Application & Benefits

**Rotatable heat dispenser:
Gets circular in every
corner!**

- Qualitative: 100% pure electrolytic copper
- Pointed: Gets into any corner
- Rotatable: 360° rotatable and 10° adjustable in the angle of inclination



Item no. 66480002

Soldering Iron Tip Bent Shape

Application & Benefits

**Rotatable heat dispenser:
Soldering in all directions!**

- Qualitative: 100% pure electrolytic copper
- Rotatable: Rotatable 360° and 10° adjustable in the angle of inclination
- Selectable: In 3 sizes available: Light, medium, heavy



Item no. 66450001

Item no.	Version	Dimensions	Weight	PU
64440086	Gas cartridge powergas, 60 g, 12 piece	170 mm	1.5 kg	12
66480002	Soldering iron tip, pointed shape	95 mm	239 g	1
66480003	Soldering iron tip, bent shape, light	100 mm	185 g	1
66450001	Soldering iron tip, bent shape, medium	110 mm	235 g	1
66480001	Soldering iron tip, bent shape, heavy	145 mm	315 g	1

Soldering Iron Tip Bent Shape Turbo

Application & Benefits

Fast colleague: Heats up furiously fast!

- Fast: 20 % faster hot due to special boring
- Qualitative: 100 % pure electrolytic copper
- Rotatable: 360° rotatable and 10° adjustable in the angle of inclination
- Selection: Available in 2 sizes: Medium, heavy



Item no. 66460001

Soldering Iron Tip Pointed Shape Longlife

Application & Benefits

Coated heat dispenser: No more cleaning again!

- Coated: Clean working without ammonia stone - cleaning by moistened cloth in hot condition
- Comfortable: No re-filing
- Rotatable: Can be rotated 360° and 10° adjustable in the angle of inclination
- Pointed: Great for corners



Item no. 66481002

Soldering Iron Tip Bent Shape Longlife

Application & Benefits

Coated heat dispenser: No more cleaning again!

- Coated: Clean working without ammonia stone - cleaning by moistened cloth in hot condition
- Comfortable: No re-filing
- Rotatable: Can be rotated 360° and 10° adjustable in the angle of inclination
- Selection: Available in 3 sizes: Light, medium, heavy



Item no. 66451001

Item no.	Version	Dimensions	Weight	PU
66460001	Soldering iron tip , bent shape, turbo, medium	110 mm	235 g	1
66470001	Soldering iron tip, bent shape, turbo, heavy	145 mm	315 g	1
66481002	Soldering iron tip, pointed shape, longlife	95 mm	240 g	1
66481003	Soldering iron tip, bent shape, longlife, light	100 mm	186 g	1
66451001	Soldering iron tip, bent shape, longlife, medium	110 mm	236 g	1
66481001	Soldering iron tip, bent shape, longlife, heavy	145 mm	316 g	1

Soldering Iron Tip Copper Tip Hammer Shape

Application & Benefits

High quality classic:
Copper piece for classic
soldering irons!

- Electrolytic copper
- Solid: Perfect fixation of the pin in the copper
- Selection: Available in 250 g and 350 g



Item no. 66490001

Soldering Iron Tip Copper Tip Zinnlux

Application & Benefits

**Coated classic: No more
timeconsuming cleaning!**

- Qualitative: 100 % pure Electrolytic copper
- Pointed: Gets into any corner
- Rotatable: 360° rotatable and 10° adjustable in the angle of inclination



Item no. 66491002

Item no.	Version	Dimensions	Weight	PU
66490001	Soldering iron tip, copper tip, hammer shape	90 mm	250 g	1
66490002	Soldering iron tip, copper tip, hammer shape	100 mm	350 g	1
66491002	Soldering iron tip, copper tip, zinnlux, hammer shape	80 mm	350 g	1

Small Bottle for Propane

Application & Benefits

Handy gas supplier: Light-weight gas bottle for flexible use!

- Light: Weighs only 1.3 kg for 425 g gas
- Enduring: 7 hours with an automatic soldering iron
- Usable: With pressure regulator and hose breaking safety device



Item no. 64440425

Hose Breaking Safety Device

Application & Benefits

Safe partner: Interrupts the gas supply in an emergency!

- Variable: Adjustable from 1,5 bar - 6 kg
- Tested: According to German standard
- DIN DVGW/91.01 e 694 FN 16

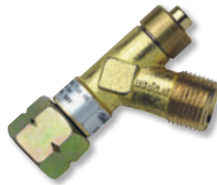

Item no. 66640000

Filling Nozzle for Propane-Small Bottle

Application & Benefits

Practical connector: For decanting from large bottles into small bottles!

- Practical: For transferring large bottles (11 kg or 5 kg) with a combi connection into a small bottle with a 3/8 left connection
- Qualitative: Made of brass



Item no. 64441425

Item no.	Version	Dimensions	Weight	PU
64440425	Small bottle for propane, 425 g	120 mm	1.3 kg	1
66640000	Hose breaking safety device	65 mm	95 g	1
64441425	Filling nozzle for propane-small bottle	75 mm	200 g	1

High Pressure Hose from Rubber

Application & Benefits

High quality friend: Because there is no alternative to rubber!

- Quality: HD rubber solder hose 4 x 4 mm
- Connecting: With double-sided 3/8" left-hand thread



Item no. 66630003

Pressure Regulator for 5 and 11 kg Gas Bottles

Application & Benefits

Practical pressure regulator: Reduces the pressure to the desired level!

- Connecting: Combi connection for large gas bottle (Combi x 3/8 left)
- Powerful: 8 kg gas flow
- Variable: Adjustable from 0 - 4 bar



Item no. 66620000

Pressure Regulator for 425 g Gas Bottle

Application & Benefits

Practical pressure regulator: Reduces the pressure to the desired level!

- Connecting: 3/8 left on both sides for gas bottle 425 g
- Powerful: 6 kg gas flow
- Variable: Adjustable from 0 - 4 bar



Item no. 66620001

Item no.	Version	Dimensions	Weight	PU
66630003	High pressure hose from rubber	3 m	520 g	1
66630005	High pressure hose from rubber	5 m	830 g	1
66630010	High pressure hose from rubber	10 m	1.5 kg	1
66620000	Pressure regulator for 5 and 11 kg gas bottles	100 mm	280 g	1
66620001	Pressure regulator for 425 g gas bottle	95 mm	230 g	1

Soldering Set Solder Max

Application

Super Cleaner: For the cleaning and tinning of the soldering iron copper piece!

Benefits & Comfort

- Universal: Compactly built, with base body in one piece
- Stable: With anti-slip mat on the back ideal for inclined surfaces
- Safe: Clamping insert in the holder prevents the ammonia stone from slipping out
- Long-lasting: Acid and heat resistant Brush with Chinese bristle

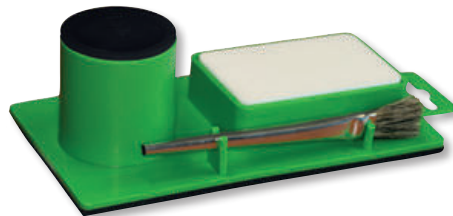

Item no. 03310000

Item no.	Version	Dimensions	Weight	PU
03310000	Soldering set Solder Max	200 x 100 mm	215 g	1



Because a cleaner belongs in the team

Especially when it brings everything with it: the ammonia stone for cleaning and tinning the soldering iron copper piece, the container for the flux/soldering fluid and the soldering fluid brush with holder. The perfect three-in-one solution for soldering even on inclined surfaces - thanks to the anti-slip mat. Really clean!

Soldering Set Solder Max Combi

Application & Benefits

Double cleaner:
With 2 soldering fluid containers and 2 brushes!

- Universal: With 2 soldering fluid containers for different applications
- Stable: With anti-slip mat on the backside, ideal for, ideal for inclined surfaces
- Safe: Clamp in the holder prevents the sal ammoniac stone from slipping out
- Durable: 2 acid and heat resistant brushes with china bristles



Item no. 03311000

Soldering Brush Heat Resistant and Acid Resistant

Application & Benefits

Practical distributor:
Distributes soldering fluid!

- Heat and acid resistant: Original china bristles
- Durable: High quality brush handle glued and pressed
- Suitable: For soldering fluids, acids, oil etc.
- Wide: 10-15 mm



Item no. 03390002

Bottle for Hydrochloric Acid/ Soldering Fluid

Application & Benefits

Stable friend: Available with and without leakage protection!

- Variations: 4 variants in blue and yellow, with and without outlet stop
- Yellow: For soldering fluid
- Blue: For hydrochloric acid
- Innovative: Optional spill stop prevents the bottle from leaking when it falls over



Color Variants



Item no. 03330000 / 03331000

Item no.	Version	Dimensions	Weight	PU
03311000	Soldering set Solder Max Combi	250 x 95 mm	270 g	1
03390002	Soldering brush, heat resistant and acid resistant	10 mm	6 g	2
03390025	Soldering brush, heat resistant and acid resistant	10 mm	75 g	25
03390100	Soldering brush, heat resistant and acid resistant	10 mm	300 g	100
03330000	Bottle for hydrochloric acid, blue	150 ml	90 g	1
03330001	Bottle for hydrochloric acid with spill stop, blue	150 ml	100 g	1
03331000	Bottle for soldering fluid, yellow	150 ml	90 g	1
03331001	Bottle for soldering fluid with spill stop, yellow	150 ml	100 g	1

Gel-Flux in a Brush Bottle

Application & Benefits

Perfect solder: Universal flux with brush bottle in gel shape!

- Universal: For all new metals except stainless steel
- Stable: Bottle with wide surface
- Clean: Brush in the lid - always with you and safely stored
- Stable: Due to its gel form it stays where it is applied, it does not run away



Item no. 66400320

Flux in a Brush Bottle

Application & Benefits

Aggressive solder: Especially for oxidized metals!

- Universal: For all oxidized metals except stainless steel
- Stable: Bottle with wide surface
- Clean: Brush in the lid - always with you and safely stored



Item no. 66401320

Flux for Copper

Application & Benefits

Special solder: Designed for copper!

- Suitable: For soldering roofs, gutters and downpipes made of copper
- Special: For brass and copper alloys
- Large: Content 1 kg



Item no. 66402000

Item no.	Version	Dimensions	Weight	PU
66400320	Gel-flux in a brush bottle	320 ml	500 g	1
66401320	Flux in a brush bottle	320 ml	500 g	1
66402000	Flux for copper	1000 ml	1 kg	1

Flux For Zinc and Galvanized Steel Sheet

Application & Benefits

Necessary assistant: For perfect soldering results!

- Suitable: Flux for soft soldering of new and oxidized titanium zinc, fine zinc and galvanized steel sheet
- Contents: Made of zinc chloride and ammonium chloride, in water-based solution with addition of free hydrochloric acid
- Large: Content 1 kg



Item no. 66402010

Flux for Oxidized Zinc Sheet

Application & Benefits

Strong supporter: When the oxide layer is already thicker!

- Suitable: Flux for soft soldering of oxidized titanium zinc, fine zinc and galvanized steel sheet
- Content: Made of zinc chloride and ammonium chloride, in water-based solution with addition of free hydrochloric acid
- Large: Content 1 kg



Item no. 66402020

Flux for Patinated Zinc Sheet

Application & Benefits

Innovative assistant: Recommended by zinc manufacturers!

- Suitable: Flux for soldering of titanium zinc and galvanized sheet steel
- Special: Particularly adapted and recommended for: RHEIN-ZINK®-walzblank, - "preweathered pro", blue-grey and slate-grey as well as NedZink "Nova".
- Contents: Soldering fluid based on zinc chloride, ammonium chloride, hydrochloric acid and solvents
- Large: Content 1 kg



Item no. 66402030

Item no.	Version	Dimensions	Weight	PU
66402010	Flux for zinc and galvanized steel sheet	1000 ml	1 kg	1
66402020	Flux for oxidized zinc sheet	1000 ml	1 kg	1
66402030	Flux for patinated zinc sheet	1000 ml	1 kg	1

Ammonia Stone for Solder Max 12 Pack

Application & Benefits

- Suitable: Soldering stone suitable for Solder Max and Solder Max Combi
- Clean: Very good cleaning characteristics
- Durable: High quality composition
- Safe: Individually shrink-wrapped

Ammonia Stone in Metal Box

Application & Benefits

Protective cleaner: The box protects tools from rust!

- Protective: The metal box protects your tools from the corrosive characteristics of an ammonia stone
- Clean: Very good cleaning characteristics
- Long lasting: High quality composition



New



Item no. 03322000



Item no. 03323000



New



Item no. 03324000

Item no.	Version	Dimensions	Weight	PU
03322000	Ammonia stone for Solder Max	81 x 51 x 20 mm	120 g	12
03322003	Ammonia stone for Solder Max, individually shrink-wrapped	81 x 51 x 20 mm	120 g	1
03323000	Ammonia stone in metal box	91 x 60 x 21 mm	140 g	1
03324000	Cleaning and tinning stone Tin Clean in metal box	91 x 60 x 21 mm	185 g	1

Ammonia Stone Six Pack

Application & Benefits

- Clean: Very good cleaning characteristics
- Durable: High-quality composition
- Handy: Handy shape of the stone
- Safe: Shrink-wrapped in a pack of 6



Item no. 03320006

Gesipa Hand Riveter NTX

Application & Benefits

Classic fixer: Robust and reliable hand riveter!

- Working range: Up to 5 mm diameter for aluminum and 4 mm diameter for stainless steel
- Imax chuck jaws 2-piece with fine toothing suitable for all riveting pliers
- For blind rivets with nominal diameter up to 3,2 mm



Item no. 01310000

Gesipa Hand Riveter Flipper

Application & Benefits

Ergonomic fixer: Power-saving due to innovative design!

- Ergonomic design
- 40 % less effort
- With rivet mandrel collecting container
- Incl. nose pieces 10/18, 10/24 and 10/29 for blind rivets up to 5 mm diameter for aluminum and 4 mm diameter for stainless steel



Item no. 01301000

Item no.	Version	Dimensions	Weight	PU
03320006	Ammonia stone six pack	65 x 45 x 40 mm	900 g	6
01310000	Gesipa hand riveter NTX	260 mm	575 g	1
01301000	Gesipa hand riveter Flipper	260 mm	750 g	1

Angle Riveting Pliers Rotatable Head

Application & Benefits

Rotatable fixer: The rivet head is completely rotatable!

- Head 360° rotatable
- Ideal for corners
- Equipped with four mouthpiece sizes



Item no. 01302000

Blind Rivets Aluminium/Steel

Application & Benefits

- Standard/Flat round head
- Aluminum/Steel
- 500 pieces per package



Item no. 01311326

Blind Rivets Aluminium/Nirosta

Application & Benefits

- Standard/Flat round head
- Aluminum/stainless steel
- 500 pieces per package



Item no. 01311136

Item no.	Version	Dimensions	Weight	PU
01302000	Angle riveting pliers, rotatable head	280 mm	750 g	1
01311326	Blind rivets aluminium/steel, ø 3.2 mm, length 6 mm	3.2 x 6 mm	590 g	500
01311328	Blind rivets aluminium/steel, ø 3.2 mm, length 8 mm	3.2 x 8 mm	650 g	500
01311048	Blind rivets aluminium/steel, ø 4 mm, length 8 mm	4 x 8 mm	805 g	500
01311136	Blind rivets alu/nirosta, ø 3 mm, length 6 mm	3 x 6 mm	495 g	500

Blind Rivets Aluminium/Stainless Steel

Application & Benefits

- Air and water tight
- Aluminum/stainless steel
- 500 pieces per package

Blind Rivets Copper/Steel

Application & Benefits

- Standard/Flat Round Head
- Copper/Steel
- 500 pieces per package



Item no. 01313280



Item no. 01312036

Item no.	Version	Dimensions	Weight	PU
01313280	Blind rivets alu/stainless steel, \varnothing 3.2 mm, length 8 mm	3.2 x 8 mm	500 g	500
01312036	Blind rivets copper/stahl, \varnothing 3 mm, length 6 mm	3 x 6 mm	635 g	500

Leather Belt

Application & Benefits

- Durable: Durable leather
- Quality: Top line quality
- Embossed: With Freund logo
- Selection: Various waist-band widths available
- Suitable: For the Freund - belt buckles (not included)



Item no. 06000800

Nail Bag Single Nail Pocket Leather

Application & Benefits

- Flat: Only 1 nail compartment
- Durable: Durable leather
- Quality: Top line quality
- Embossed: With Freund logo
- Durable: Riveted and sewn



Item no. 06020000

Nail Bag Two Nail Pockets Leather

Application & Benefits

- Practical: With 2 nail compartments
- Durable: Durable leather
- Quality: Topline quality
- Embossed: With Freund logo
- Durable: Riveted and sewn



Item no. 06021000

Item no.	Version	Dimensions	Weight	PU
06000800	Leather belt, waist size 80 cm	900 mm	125 g	1
06000900	Leather belt, waist size 90 cm	1000 mm	135 g	1
06001000	Leather belt, waist size 100 cm	1100 mm	150 g	1
06001100	Leather belt, waist size 110 cm	1200 mm	170 g	1
06001200	Leather belt, waist size 120 cm	1300 mm	175 g	1
06001300	Leather belt, waist size 130 cm	1400 mm	180 g	1
06020000	Nail bag, single nail pocket, leather	170 x 160 mm	145 g	1
06021000	Nail bag, two nail pockets, leather	180 x 170 mm	170 g	1

Nail Bag Two Nail Compartments, Bright Leather

Application & Benefits

- Practical: With 2 nail compartments
- Durable: Durable bright leather
- Quality: Topline quality
- Embossed: With Freund logo
- Durable: Riveted and sewn



Item no. 06023000

Hammer Holder Genuine Leather

Application & Benefits

- Durable: Durable genuine leather
- Safe: With metal clip and safety tab



Item no. 06060000

Hammer Loop Genuine Leather

Application & Benefits

- Practical: Belt pouch for transport of a hammer
- Durable: Durable genuine leather
- High quality: Riveted from 3 parts



Item no. 06080000

Item no.	Version	Dimensions	Weight	PU
06023000	Nail bag, two nail compartments, bright leather	180 x 150 mm	190 g	1
06060000	Hammer holder, genuie leather	150 mm	95 g	1
06080000	Hammer loop, genuie leather	180 mm	45 g	1

Leather Pouch for Hammer Tacker

Application & Benefits

- Durable: Durable leather
- Durable: Riveted and stitched
- Practical: Integrated staple pocket
- Selection: Small and large version available for Hammer tacker 19 and 11



Item no. 06012000/06013000

Knife Pouch Small Version

Application & Benefits

- Durable: Durable leather
- Durable: 5-fold riveted and sewn
- Quality: Topline quality
- Embossed: With Freund logo



Item no. 06090000

Knife Pouch Big Version

Application & Benefits

- Durable: Durable leather
- Durable: Riveted and sewn
- Quality: Topline quality
- Embossed: With Freund logo



Item no. 06093000

Item no.	Version	Dimensions	Weight	PU
06012000	Leather pouch for Hammer Tacker 19	160 mm	95 g	1
06013000	Leather pouch for Hammer Tacker 11	165 mm	175 g	1
06090000	Knife pouch, small version	225 mm	60 g	1
06093000	Knife pouch, big version	250 mm	70 g	1

Buckle for Various Trades

Application & Benefits

- Appealing: Belt buckle made of nickel silver and brass
- Durable: High-quality workmanship
- Selection: Emblem for roofers and carpenters



Item no. 06030000

Hammer Chain Three Steel Chains

Application & Benefits

- Durable: Loops made of durable leather
- Durable: Connections riveted
- Strong: The 3 chains are made of high quality steel and finished to resist corrosion



Item no. 06050003

Hammer Chain Two Lion Head Embroides

Application & Benefits

- Decorative: Equipped with 2 lion head emblems
- Tough: The 3 chains are made of high quality steel and refined to resist corrosion



Item no. 06070000

Item no.	Version	Dimensions	Weight	PU
06030000	Buckle roofer brass emblem	65 mm	45 g	1
06031000	Buckle carpenter brass emblem	65 mm	45 g	1
06050003	Hammer chain, three steel chains	380 mm	76 g	1
06070000	Hammer chain, two lion head embroides	340 mm	250 g	1

Knife Pouch for Insulation- Knives

Application & Benefits

- Protective: Optimal protection of the blade of the Freund insulation knife 02055000
- Durable: Hard-wearing leather
- Durable: 15 x riveted and neatly sewn



Item no. 06094000

Work Apron With Belt And Buckle

Application & Benefits

- Not disturbing: Tool apron made of extremely soft genuine leather
- Equipped: With 2 nail pockets, Hammer loop, 2 single holders
- Adjustable: Durable belt adjustable up to 119 cm



Item no. 06104000

Leather Belt Bag

Application & Benefits

- Durable: Durable leather
- Rugged: Riveted and sewn
- Substantial: 5 pockets of different sizes + 1 loop

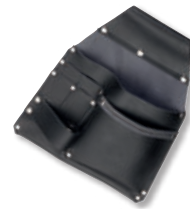

Item no. 06110000

Item no.	Version	Dimensions	Weight	PU
06094000	Knife pouch for insulation knives	280 mm	65 g	1
06104000	Work apron with belt and buckle	900 mm	560 g	1
06110000	Leather belt bag	230 x 240 mm	440 g	1

Tool Box, Small Strong Box

Application & Benefits

**Ingenious companion:
Transports tools and
accessories!**

- Robust: Made from durable PP. Equips you for use on your next construction site
- Handy and resilient: 14 liters of storage space and 20 kg load capacity including tool
- Dry and clean: contents are protected from water and dust thanks to the seal in the lid (IP 55)
- Clearly arranged: removable organizer
- Practical: the V-groove with ruler on the top of the lid holds materials such as wood and pipes in position for cutting



Item no. 45174000

Item no.	Version	Dimensions	Weight	PU
45174000	Tool box, small strong box	242 x 256 x 462 mm	2.1 kg	1

Tool Box Freund

Application

Ingenious companion: Transports tools and accessories!



New

Benefits & Comfort

- **Robust:** Made from durable PP. Equips you for use on your next construction site
- **Large and resilient:** 29 liters of storage space and 30 kilogram load capacity including tools
- **Dry:** Contents are waterproof and weather resistant according to IP 55
- **Clearly arranged:** Removable organizer
- **Practical:** The V-nut with ruler on the top of the lid holds materials such as wood and pipes in position for cutting



Item no. 04569000

Item no.	Version	Dimensions	Weight	PU
04569000	Tool box Freund	660 x 275 x 26 mm	2.7 kg	1



Because you need a best friend

You have found it with this toolbox. Huge capacity, always clearly arranged, stable and with high carrying capacity. And with enough space for your tools. Protected from water and dust - It can really take a hit.

Bucket Bag Tool Buddy

Application

Strong bag: Stows and transports your tools - Combined with a standard 12 liter construction bucket!

Benefits & Comfort

- Organized: 6 pockets each on the inside and outside for various tools
- Practical: 3 holding loops on one outside of the insert for longer tools
- Closing: Integrated inside rubberized cover incl. cord
- Dry and clean: Cover protects bucket contents from dust and is water-repellent
- Convenient: Easy to attach to a standard 12 liter bucket
- Durable and practical: Robust and tear-resistant fabric



Item no. 45181000

Item no.	Version	Dimensions	Weight	PU
45181000	Bucket bag Tool Buddy	Ø 300 x 350 mm	470 g	1
45183000	Bucket bag Tool Buddy in a set with construction bucket 12 liters	Ø 300 x 350 mm	930 g	1

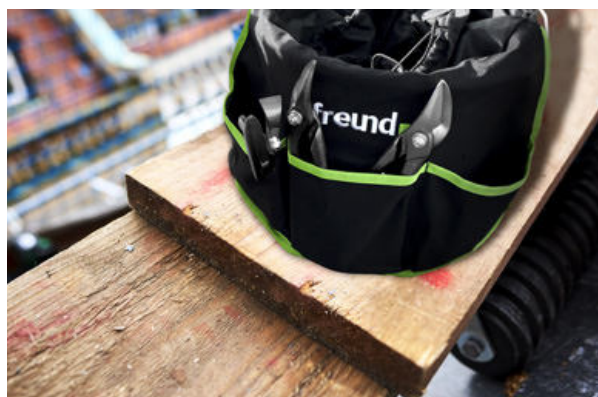

Because everything has its place

With the versatile Tool Buddy bucket bag, you can store and transport everything you need on your construction site. So you always have everything at hand. Simply pull the strong bag over your construction bucket, put the tools in it and off you go!

Jewellery Hammer with Surface Refinement

Application

Shining jewel: Spreads joy and pride!

Benefits & Comfort

- Exclusive: Triple surface finish in chrome, old copper or 24 carat gold
- Impressive: The jewellery hammer is 100 % handmade for you
- Optional: Individual engraving on your jewellery hammer and noble gift box made of wood incl. foam inlay as an addition to your Jewellery hammer (extra charge)
- **Caution:** Pure jewelry tool - surface finish is heavily attacked during work



Item no. 07001000



Item no. 07000000



Item no. 07002000

Item no.	Version	Dimensions	Weight	PU
07002000	Jewellery hammer gold plated finish	340 mm	650 g	1
07001000	Jewellery hammer chrome finish	340 mm	650 g	1
07000000	Jewellery hammer old copper version	340 mm	650 g	1



Because you deserve something special

For top performance and hard work, no matter what the weather is like. Our Jewellery hammer is just the right thing. As gift for yourself or to give pleasure to others. For example, for the farewell of a colleague or a colleague into retirement. Or for the just passed master examination. With an engraving on top of it even becomes an original.

Present Box Made of Wood for Jewellery Hammer

Application & Benefits

Noble case: Transports and protects your jewellery hammer!

- Exclusive: High-quality made of wood
- Protective: Incl. foam inlay, which protects your refined jewellery hammer from scratches



Item no. 07004000

Individual Engraving

Application & Benefits

You want to make a true unique piece out of your slate hammer? Then our optional engravings are just the thing for you. Whether company logo, text message or both combined. Almost anything is possible here. Curious?

Then simply send us your inquiry with your engraving request to **sales@freund-cie.com** and we will send you a suitable offer. We are looking forward to your request!

Item no.	Version	Dimensions	Weight	PU
07004000	Present box made of wood for jewellery hammer	360 x 252 x 35 mm	750 g	1
17010000	Gravur			1

Bottle Opener Powder Coated

Application & Benefits

The opening friend:
We also think of your physical well-being!

- Exclusive: Freund slate hammer for opening a bottle
- Corrosion protected: High-quality powder coating in green



Item no. 06387000

Shopping Cart Token Freund-Coin

Application & Benefits

The shopping friend:
The trolley token, that you always have with you!

- Fixable: The Freund token is attached to your key ring and always with you
- Practical: The Freund-Token does not remain in the in the shopping cart, but on your key ring
- Decorative: With laser-etched logo



Item no. 06370000

Item no.	Version	Dimensions	Weight	PU
06387000	Bottle opener, powder coated	125 mm	60 g	1
06370000	Shopping cart token Freund-Coin	86 mm	18 g	1

Plate Lift GS-Tested

Application & Benefits

- Variable: For plate size 300 - 500 mm
- Safe: GS-tested



Item no. 02840000

Plate Lift Reinforced Version

Application & Benefits

- Variable: Individually adapted to the plate size of 400 - 600 mm adjustable
- Strong: Suitable for heavy plates



Item no. 02842000

Metal Drills

Application & Benefits

- High-quality: Made of high-performance high-speed steel
- Sharp: Profile ground
- Centered: Cross ground according to DIN 1412 C

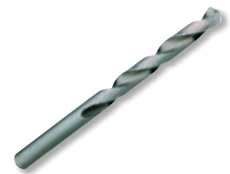

Item no. 01581000

Item no.	Version	Dimensions	Weight	PU
02840000	Plate lift, GS-tested	300 - 500 mm	1.1 kg	1
02842000	Plate lift, reinforced version, adjustable	400 - 600 mm	1.6 kg	1
01581000	Metal drills, 1 piece	3.2 x 65 mm	10 g	1
01581400	Metal drills, 1 piece	4.2 x 75 mm	10 g	1

Scaffolding Rope

Application & Benefits

- Robust: High-quality polypropylene
- Strong: Diameter of 9 mm
- End: With eyelet and blunt end



Item no. 00642003

Rope Hook

Application & Benefits

- Robust: Tips forged
- Durable: Galvanized tool steel
- Weight: 650 g, own weight holds 175 kg



Item no. 00570000

Ginney-Wheel

Application & Benefits

- Safe: Rotatable load hook with hook safety device
- Loadable: Lifts depending on version 220 kg or 250 kg
- High-quality: With crossbars



Item no. 00560220

Item no.	Version	Dimensions	Weight	PU
00642003	Scaffolding rope, breaking load ca. 100 kg	3 m	60 g	1
00642025	Scaffolding rope, breaking load ca. 100 kg	2.5 m	50 g	1
00570000	Rope hook	260 mm	650 g	1
00560220	Ginney-wheel up to 220 kg		4.6 kg	1
00560250	Ginney-wheel up to 250 kg		5 kg	1

Steel Wire Brush

Application & Benefits

- Robust: Beech wood handle
- Fixed: Firmly connected steel bristles in 5 rows
- Hanging: Hanging hole in the handle



Item no. 01830000

Brass Wire Brush

Application & Benefits

- Robust: Beech wood handle
- Fixed: Firmly connected soft brass bristles in 5 rows
- Hanging: Hanging hole in the handle



Item no. 01831000

Item no.	Version	Dimensions	Weight	PU
01830000	Steel wire brush	280 mm	145 g	1
01831000	Brass wire brush	280 mm	150 g	1

Holstein Sand Shovel

Application & Benefits

- Steel hard: Made from hardened steel
- High quality: Long service life and wear-resistant, corrosion-resistant red paint
- Applicable: For sandy and fine excavation
- Suitable: For commercially available shovel handles. Painted in red
- Large: Size 2



Item no. 92100002

Item no.	Version	Dimensions	Weight	PU
92100002	Holstein sand shovel	340 x 250 mm	1.2 kg	1
92111300	Shovel handle	1.300 mm	500 g	1



Quick finder

6D Pipe expander	223	Break-off blades	86
A		Broad seaming pliers	144
Aluminium safety handle	83	Bucket bag Tool Buddy	249
Ammonia stone	238, 239	Buckle for various trades	245
Ammonia stone in metal box	238	C	
Ammonia stone for Solder Max	238	Cardboard tracing knives	87
Angle flat scraper	173	Carpenter's square	107
Angle riveting pliers rotatable head	240	Carpenters pen	121
Assembly hammer with steel tube	213	Chains	245
Automatic soldering iron	227	Chalk line double version	115
B		Chalk line ergo	118
Batten gauge aluminium version	106	Chalk line maxistronger line	118
Batten gauge u-profile rod	106	Chalk line straitline, 3,5-times	118
Berlin pattern snips	179	Chalk line turbospeed plus 5-times	117
Berlin roof trowel with wooden handle	98	Chalk lines turbospeed	117
Biko-knife with fixed blade	81	Chalk line freund	114
Bitumen Pro bitumencuttter	51	Chalk powders for chalk line	120
Bitumen roller	69	Chase wedge hardwood	199
Bitumencutter Bitumen Pro	51	Chase wedge HDPE plastic	197
Blades 10 pieces	86	Chaulking gun closed model	105
Blind rivets aluminium/stainless steel	241	Chaulking gun extremely robust	105
Blind rivets aluminium/steel	240	Chaulking gun skeleton shape	105
Blind rivets copper/steel	241	Chisel	41
Blind rivets aluminium/nirosta	240	Claw hammer with leather handle	41
Bottle for hydro-chloric acid/soldering fluid	235	Clipping shears system 133 AKW	171
Bottle opener powder coated	252	Coil clamp	195
Bottle with brush for solvent welding material	69	Combi-roller solvent resistant	70
Bow compass	111	Combination cutting snips	183, 184, 186
Brass wire brush	255	Combination snips	177, 180

Comfort knife foldable	82	Flanging tool	172
Cord spirit level	112	Flat nose pliers	151
Corner seaming pliers	150	Flat roof starter kit	62
Cutting snips compound leverage	187	Flat roof starter kit with Ergowheel®	64
D		Fliz-folder	172
Danish roof trowel	97	Flooring crow bar	36
Deadblow hammer	208	Flux for copper	236
Demolition tool BOZZ	31	Flux for oxidized zinc sheet	237
Demolition tool BOZZ set	33	Flux for patinated zinc sheet	237
Demolition tool little BOZZ	32	Flux for zinc and galvanized steel sheet	237
Disc-bender	136	Flux in a brush bottle	236
Double disc-bender	136	Foam Master XXL metal foam gun	103
Double max-bender 350	137	Foam rubber	71
Double premium bender	137	Foil scissors with soft handle	68
Double square-seam	168	Foil scissors with soft handle	68
Double square-seam folder	167	Foil scissors sturdy metal design	67
Double standing seam closer with PVC jaws	165	Folder second stage upright	168
Double utility bar, 380 mm	36	Folding saw japanese pull saw blade	94
Double welt iron	174	Frame saw japanese pull saw blade	94
E		Freund wooden folding rule	112
Eave closer with PVC jaws	166	Freund-knife handy handle and quiver	83
Eaves closer	168	G	
Eaves edger	168	Gas cartridge powergas	229
Ergowheel® pressure roller	54	Gel-flux in a brush bottle	236
Fibre cement guillotine 96	23	Genuine aviation snips	188 - 189
Fibre-cement scribe	24	Genuine shape cutting snips	178, 181
Files for soft metals	200	Gesipa hand riveter NTX	239
Fillet weld slide PTFE non-stick	59	Gesipa hand riveter Flipper	239
Filling nozzle for propane-small bottle	232	Ginney-wheel	254

Grooving hammer	210	Handle for slate ripper	29
Grooving hammer two-headed	212	Handle for slate ripper straight form	29
Guide for fibre cement guillotine	24	Handle from ash wood	42
Gutter adjustment pliers	216	Hannover roof trowel	97
Gutter adjustment pliers universal	224	Hatched with handle	42
Gutter cleaning kit	219	High pressure hose from rubber	233
Gutter cord	113	Holstein sand shovel	256
Gutter hanger bender	215	Hooked blades "Made in Solingen"	85
Gutter hanger bender Transfor.Maxx	214	Hooked blades	85
H		Hooked break-off blades	86
Hacksaw for pipes and gutters	89	Hose breaking safety device	232
Hacksaw with metal saw blade	89	Hot air gun with gas cartridge	228
Hacksaw with wood saw blade	89	I	
Hammer chain three steel	245	Insulation knife with long blade	88
Hammer chain two lion head embroides	245	Insulation knife with wooden handle	88
Hammer drill SDS-Plus	46	Insulation material saw	93
Hammer for angle flat scraper	211	J	
Hammer holdergenuine leather	243	Japanese pull saw with plastic	95
Hammer loop	243	Japanese pull saw with rattan	95
Hammer tacker	75	Jewellery hammer	251
Hammer tacker Freund 11	74	Jig saws	92
Hammer tacker Freund 19	73	Knife pouch for insulation-knives	246
Hammer tacker Freund Fast & Fix F11	72	Knife pouch big version	244
Hammer tacker Rapid 11	74	Knife pouch small version	244
Hammer tacker Rapid 19	74	L	
Hammer tacker Freund 53	75	Lath axe with soft handle	42
Hammer tacker Rapid 54	75	Lath lifter	34
Hand notcher 35	156	Lead dressers	196 - 199
Hand notcher with 2K softhandle	157	Leather belt	242, 246

Leather pouch for hammer	244	Nail bag single nail pocket	242
Locking pliers, curved jaws	160	Nail bag two nail pockets	242
Locksmith square	108	Nail claw hook	37
Locksmith's hammer	213	Nibbler shears	191
Long nose locking	159	Notching and punching pliers	157
Loop Pro coil clamp	195	O	
M		Offset cutting snips	185, 187
Masonry cord polyethylen red	113	Offset cutting snips mini	188
Masonry cord polypropylene red	113	P	
Masonry trowel with wooden handle	98	Paint brush bent long	70
Max-bender 350	137	Paint brush straight short	71
Max-bender 350 with handle	135	Pelican snips	177, 180, 182, 184, 185
Metal drills	253	Pipe crimper compound leverage	217
Metal foam gun Foam Master XXL	103	Pipe crimper curved	217
Metal saw bow with 2K-grip	90	Pipe crimper straight	217
Metal saw bow with pistol grip	90	Pipe expander	224
Metall foam gun Plus	104	Pipe expander in a set 100 / 120 mm	225
Metall foam gun Plus XL	104	Pipe expander in a set 67/87/100 mm	226
Mini water pump pliers	161	Pipe expander in a set 80 / 100 mm	225
Mini-seaming pliers curved 45°	145	Pipe expander in a set 87 / 100 mm	225
Mini-seaming pliers, straight	146	Pipe expander in a set 87/100/120 mm	226
Modeling slater's hammer Universo®	13	Planishing and grooving hammer	212
Mortise axe	41	Plaster-board saw	93
Multigraph pen	121	Plastic bottle with drip cap	68
Multi purpose saw	91	Plate lift reinforced version	253
Multi purpose saw 3D-teeth	91	Plate liftgs-tested	253
Multitool	83	Pointing hammer with fiberglass handle	14
N		Pointing hammer with wooden handle	14
Nail bag two nail	243	Polishing hammer two-headed	212

Premium multi purpose saw	91	Roofer's hammer with reinforced head protection	38
Premium-bender	137	Roofer's hammer one piece forged steel	38
Premium-bender	134	Roofer's hammer with leather handle	39
Present box	251	Roofing membrane roller	66
Pressure regulators for gas bottles	233	Roofing saw 2K grip	93
Pressure rollers	56 - 57	Rope hook	254
Pressure roller PTFE non-stick	58	Round dormer closer	169
Professional cutter plus	79	Round nose pliers	151
Professional cutter premium	82	Round profil closer	169
Professional cutter with break-off blades	81	Round seaming pliers	150
Professional marking set	121	Rubber hammer with wooden handle	213
Protractor powder coated	107	S	
Punch snips	178, 181 -184	Saws	89 - 95
Punching plierscompound leverage	157	Scaffolding rope	254
P		Scriber with carbide tip	111
Rabitz pliers	162	Scribing plates	109 - 110
Radii-edger	136	Scribing tool Alpha	107
Rapid 23	75	Seam locking pliers with PVC protection	158
Ridge trowel	96	Seam opening pliers	150
Roll bag with seaming pliers	143	Seam tester 90° angled	60
Roll bag with stainless steel snips	182	Seaming iron long blade	173
Roll bag-up with offset cutting snips	190	Seaming iron short blade	172
Roll-up bag with snips	179	Seaming iron without prisma	173
Roll-up bag with genuine aviation snips	190	Seaming machine Seaming Pro® NG	122 - 127
Rolling hand shears HSG	191	Seaming pliers, curved 90°, lap joint	143
Roof tile cutter Bibermax	43	Seaming pliers, curved 45°, lap joint	154
Roof tile file	45	Seaming pliers, curved 45°, stack joint	155
Roofer's hammer Freund by Picard	39	Seaming pliers, curved 90°, stack joint	147
Roofer's hammer with head protection	38	Seaming pliers, curved 45°, stack joint	146

Seaming pliers, curved 45°, lap joint	142	Slate ripper straight handle	30
Seaming pliers, skewed	154	Slate- & fibre cement cutter MasterCut®	16
Seaming pliers, straight, stack joint	155	Slate- & fibre cement cutter with punch	17
Seaming pliers, straight, lap joint	153	Slate- & fibre cement cutter ErgoCut	17
Seaming pliers, bent, compound leverage	152	Slate- & fibre cement cutter without punch	17
Seaming pliers, straight, compound leverage	152	Slater's anvil Hau.Maxx, curved	18
Seaming pliers, straight, stack joint	146	Slater's anvil Hau.Maxx, straight	19
Seaming pliers, straight, lap joint	143	Slater's anvil curved	20
Seaming Pro® NG seaming machine	126	Slater's anvil french pattern	21
Shark knife with retractable blade	78	Slater's anvil french pattern	21
Sheet bending jaws 1000 mm	170	Slater's anvil straight	20
Sheet bending jaws 300 mm	169	Slater's hammer rhenish pattern	10
Sheet bending jaws 500 mm	170	Slater's hammer american pattern	10
Sheet metal contractor box	201	Slater's hammer Piccolo with nail puller	13
Shopping cart token Freund-coin	252	Slater's hammer Piccolo with three holes	13
Shrinking hammer with different faces	211	Slater's hammer saxon pattern	10
Shrinking hammer with flat surfaces	211	Slater's hammer Universo®	13
Silicon pressure roller	53	Slater's hammer Universo®	9
Silikon-pressure roller angled	55	Slater's hammer Universo® french pattern	11
Silikon-pressure roller bush bearings	55	Slater's hammer Universo® ornament	12
Silikon-pressure roller wide, bush bearings	55	Slater's hammer french pattern	11
Silver-knife with retractable blade and quiver	81	Slater's hammer traditional french pattern	11
Single handed edger 108 HK	152	Small bottle for propane	232
Slate cutter Schiefermax	22	Small strong box	247
Slate lifting bar	37	Smooth-running ball bearings	54
Slate ripper exchange blade	29	Smooth-running ball bearings	58
Slate ripper stainless steel	28	Snips	188
Slate ripper handforged	25	Soft face hammer	208
Slate ripper spring steel	30	Soldering brush heat resistant and acid resistant	235

Soldering iron tip	229		
Soldering iron tip bent shape turbo	230		
Soldering iron tip bent shape longlife	230		
Soldering iron tip pointed shape longlife	230		
Soldering iron tip copper tip hammer shape	231		
Soldering iron tipcopper tip Zinnlux	231		
Soldering iron tippointed shape	229		
Soldering iron with combustion chamber	227		
Soldering iron with piezo ignition	228		
Soldering set in a metal case	227		
Soldering set Solder Max Combi	235		
Soldering set Solder Max	234		
Special gutter cord	113		
Spindel roller for combination	70		
Spirit level aluminium	108		
Square-seam folder	167		
Square-seam folder first stage upright	167		
Squeezing folding pliers	175		
Squeezing folding pliers, straight, lap joint	149		
Squeezing folding pliers, straight, stack joint	148		
Stainless steel seaming pliers, straight, lap joint	147		
Stainless steelseaming pliers 45°,lap joint	147		
Standard-bender	135		
Staples flat wire 11/10	77		
Staples flat wire 11/14	77		
Staples round wire 37/6	76		
Staples round wire 37/8	76		
Steel snips	182		
Steel wire brush	255		
		T	
		Tile drill	46
		Tile edger large version	170
		Tile edger small version	171
		Tile nibbler forged	44
		Tin clean in metal box	238
		Tinman's hammer, PVC angular	207
		Tinman's hammer, PVC round	207
		Tinman's hammer, PVC angular with pointed head	206
		Token Freund-coin	252
		Tongue shaped trowels	96, 97
		Tool box, small strong box	247
		Tool box Freund	248
		Tool buddy bucket bag	249
		Trapezoid blades "Made in Solingen"	84
		Trapezoid blades	84
		Triangle bearing scraper	199
		Triangle tip and belt pouch	92
		Trowels	96 - 98
		Turbo cutter cordless screw-driver	191
		U	
		UltraVision seaming pliers 45°, stack joint, window & scale	140
		UltraVision seaming pliers 90°, stack joint, window & scale	141
		UltraVision seaming pliers, straight, stack joint, window & scale	141
		Universal drill Goldcraft	46
		Universal knife curved	80
		Universal knife fixed blade	80

Universal knife with retractable blade	80
Universal replacement line on card	119
Universal replacement line on reel	119
Universal sheet metal pliers	159
Universal snips	178 - 179
Universal double bracket heat resistant	69
Upright snips compound leverage	190
W	
Water dozer	71
Water dozer hard rubber	71
Water pump pliers	162
Water pump pliers	162
Wide jaw locking pliers with PVC protection	159
Winding core	66
Wooden axe with handle from ash wood	42
Wooden bevel with brass fitting	108
Wooden hammer with metal ring	209
Wooden-tinman's hammer angular	209
Wooden-tinman's hammer round	209
Work apron with belt and buckle	246
Wrecking bar angular	36
Wrecking bar heavy duty	35
Z	
Zinc scriber hardened tip	200
Zinc scriber carbide tip	200

freund 

P. F. Freund & Cie. GmbH
Hahnerberger Str. 94-96
42349 Wuppertal
Germany

T +49 202 40929-0
info@freund-cie.com

www.freund-cie.com